

2026



silikomart®
MADE IN ITALY

Manifesto

We shape your emotions.

The passion for the art of pastry-making is in our DNA.

Innovation is the way we think about the world.

Made in Italy is our belief.

Being a big family is our strength. For over 20 years.

We design avant-garde pastry-making moulds that we hope to push towards new frontiers.

Furthermore, we enter uncharted territories and move the limits of what can be done to create new ways of baking.

Silikomart supports the pioneers of this art. We transform the creative genius of some of the greatest pastry chefs of our time into extraordinary and revolutionary works of art.

Italian design and production: a unique combination and a guarantee of quality and excellence throughout the world.

A passionate team of people here to inspire your creativity and shape it.

Diamo forma alle tue emozioni.

La passione per l'arte della pasticceria è il nostro DNA.

L'innovazione è il nostro modo di pensare al mondo.

Il Made in Italy è il nostro credo.

L'essere una grande famiglia la nostra forza. Da più di 20 anni.

Disegniamo forme d'avanguardia per la pasticceria che vogliamo spingere verso nuove frontiere.

Esploriamo nuovi territori, spostiamo i limiti del realizzabile per creare le nuove forme del gusto.

Siamo al fianco dei pionieri di quest'arte. Trasformiamo il genio creativo dei più grandi maestri pasticceri contemporanei in opere d'arte straordinarie e rivoluzionarie.

Design italiano e produzione italiana: un connubio unico, garanzia di qualità ed eccellenza in tutto il mondo.

Un team appassionato di persone per ispirare la tua creatività e darle forma.



THE ORIGINAL SILIKOMART PLATINUM SILICONE L'ORIGINALE SILICONE PLATINUM SILIKOMART



• Top quality food grade platinum silicone. Silicone platinum alimentare di qualità premium.



• 100% safe for health. 100% sicuro per la salute.



• Heat resistance. Resistenza termica.



• Easy to wash. Facile da pulire.



• Unbreakable. Infrangibile.



• Space-efficient. Salvaspazio.



REUSE

• Re-usable. Riutilizzabile.

• 3000 guaranteed baking. 3000 cotture garantite.



• BPA Free.



3D effect
Effetto 3D

INNOVATIVE MATERIALS - MATERIALI INNOVATIVI

T PLUS

The new **TPlus** technology by Silikomart has been used to develop moulds made of a special oven-ready material.
*La nuova tecnologia **TPlus** di Silikomart per realizzare stampi fatti di un materiale totalmente fornabile.*

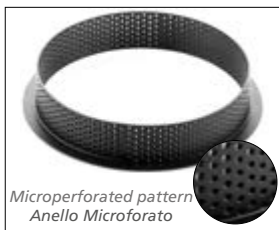

- + High quality material resistant to high temperatures (up to 356°F).

Materiale di altissima qualità resistente ad alte temperature (fino a 180°C).

- + Easy unmoulding thanks to the non-stick characteristics of the material.

Facile sformatura grazie alle proprietà antiaderenti del materiale.



- + Dishwasher safe, the mould remains unaltered.

Lavabile in lavastoviglie, lo stampo rimane inalterato.



- + Oven-ready material for a 100% accurate shape in the result.

Può essere usato direttamente in forno, per una riuscita della forma precisa al 100%.

- + Impact resistant, even from accidental drops.

Resistente agli urti, anche nel caso di cadute accidentali.



- + Long-lasting shape.

Mantiene perfettamente la forma nel tempo.

INNOVATIVE MATERIALS - MATERIALI INNOVATIVI

tritan™
from eastman



CLARITY



DURABILITY



SAFETY



STYLE



La superiorità di **Tritan™** rispetto alle altre materie plastiche è stata chiaramente dimostrata e la qualità dei nostri stampi garantisce un ottimo grado di stampaggio ed un'eccellente purezza del materiale. I prodotti realizzati con **Tritan™** hanno un'estrema durezza, infatti hanno una resistenza agli urti di gran lunga maggiore rispetto ad altre plastiche e vetro, resistendo straordinariamente agli urti, ai graffi e alle ammaccature, mantenendo queste proprietà anche dopo anni di utilizzo e migliaia di lavaggi in lavastoviglie. **Tritan™** non contiene BPA, BPS (bisfenolo S) e altri bisfenoli, è questa peculiarità a rendere **Tritan™** un materiale adatto al contatto con gli alimenti. Gli stampi Chocado sono realizzati con il materiale innovativo **Tritan™**.



*The superiority of **Tritan™** over other plastics has been clearly demonstrated and the quality of our moulds guarantees an excellent degree of moulding and material purity. Products made with **Tritan™** have extreme durability, in fact, they have a greater impact resistance than other plastics and glass, impressively resisting to bumps, scratches and dents, retaining these properties even after years of use and thousands of dishwasher washes. **Tritan™** does not contain BPA, BPS (bisphenol S) or other bisphenols, this fact ensures absolute reliability of these **Tritan™** products for food contact. Chocado moulds are made with the innovative material **Tritan™**.*



XS CREATIONS

CREAZIONI XS





Teddy Bear XS²⁰

Size: 50 x 35.7 h 20.5 mm
Volume: 20 ml Cavities: 18
36.476.87.0065

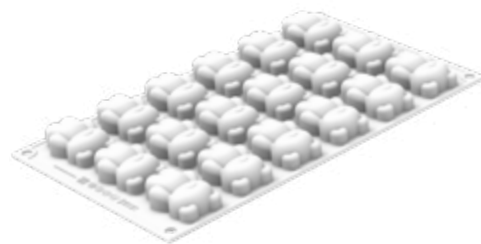

Bignè Perfetto¹⁴

Size: Ø 35 h 20 mm
Volume: 14 ml Cavities: 18
36.464.87.0065



Fiore XS¹³

Size: Ø 42 h 15 mm
Volume: 12.5 ml Cavities: 18
36.474.87.0065





Cuore XS¹³

Size: 34 x 33 h 20 mm
Volume: 13 ml Cavities: 18
36.466.87.0065



Crostata XS²⁰

Size: Ø 44 h 17 mm
Volume: 20 ml Cavities: 15
36.457.87.0065



Slice XS¹⁴

Size: 38.2 x 31 h 20 mm
Volume: 14 ml Cavities: 21
36.435.87.0065



Conceived with
**Xavi
Donnay**



Donut XS¹²

Size: Ø 34 h 16.5 mm
Volume: 12.3 ml Cavities: 18
36.434.87.0065



Conceived with
**Xavi
Donnay**



Cacao XS¹²

Size: 50 x 28 h 19 mm
Volume: 12.5 ml Cavities: 16
36.407.87.0065





Rombo XS¹⁶

Size: 53 x 33 h 18 mm
 Volume: 16 ml Cavities: 20
36.410.87.0065

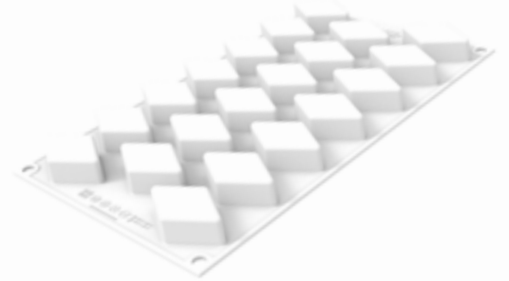

Quadrato XS²⁰

Size: 37 x 37 h 16 mm
 Volume: 20 ml Cavities: 24
36.404.87.0065



Éclair XS¹⁴

Size: 55 x 17 h 17 mm
 Volume: 14 ml Cavities: 20
36.426.87.0065





Madeleine XS¹³

Size: 44 x 32 h 16 mm
Volume: 13 ml Cavities: 18
36.408.87.0065



Charlotte XS¹⁶

Size: Ø 38 h 18 mm
Volume: 16 ml Cavities: 18
36.425.87.0065





Torta XS¹⁴

Size: Ø 40 h 15 mm
 Volume: 14 ml Cavities: 18
36.444.87.0065



Quenelle XS¹⁰

Size: 44 x 21 h 20 mm
 Volume: 10 ml Cavities: 20
36.325.87.0065



Truffles²⁰

Size: Ø 32 h 28 mm
 Volume: 20 ml Cavities: 15
36.172.87.0065



3D DESIGN | SINGLE PORTIONS MONOPORZIONI





Rabbit⁷⁰

Size: 76 x 50 h 28.5 mm
Volume: 70 ml Cavities: 8
36.463.87.0065

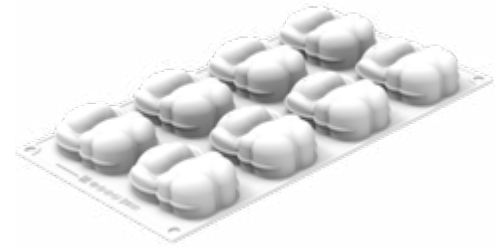

Double use cutter



Conceived with
Juan
Gutierrez

Teddy Bear⁶⁸

Size: 78.5 x 56 h 27 mm
Volume: 68.5 ml Cavities: 8
Item: 36.441.87.0065

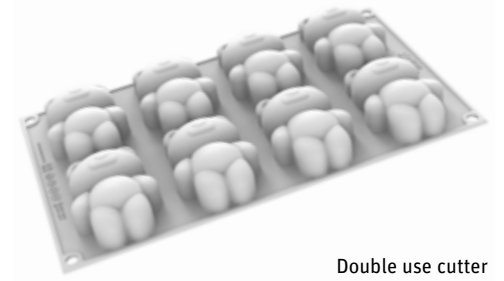

Double use cutter



Conceived with
Eunji
Lee

Charlotte¹⁰⁰

Size: Ø 70 h 32.5 mm
Volume: 100 ml Cavities: 6
36.468.87.0065

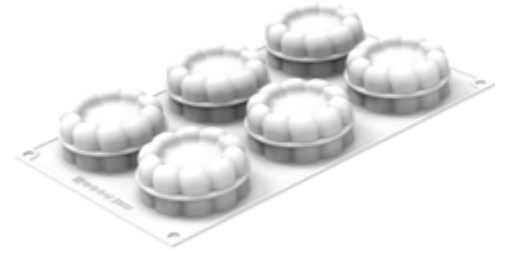

Antea¹³⁰

Size: Ø 62 h 51 mm
Volume: 130 ml Cavities: 8
36.475.87.0065



Conceived with
Tom
Coll

Tom Coll



Neve¹¹⁰

Size: Ø 70 h 30 mm

Volume: 110 ml Cavities: 6

36.405.87.0065



Truffles¹²⁰

Size: Ø 62 h 52 mm

Volume: 120 ml Cavities: 8

36.192.87.0065





Delica

Size: Ø 67 h 50 mm
Volume: 100 ml Cavities: 6
26.433.13.0065



Méduse

Size: Ø 58 h 56 mm
Volume: 115 ml Cavities: 8
26.439.13.0065



Sweet Layers

Size: Ø 55 h 55 mm
Volume: 120 ml Cavities: 8
26.431.13.0065



Double use cutter



Conceived with
**Carl
Marletti**

Mini Hiver

Size: Ø 70 h 30 mm
Volume: 108 ml Cavities: 6
26.432.13.0065



Egg Hunt

Size: Ø 53 h 67 mm
Volume: 100 ml Cavities: 11
26.421.13.0065



Sapin Magique

Size: Ø 67 h 74 mm
Volume: 85 ml Cavities: 6
26.409.13.0065



Conceived with
Enzo Roussel
Christophe Roussel





Mini Wave

Size: Ø 73 h 41 mm
Volume: 105 ml Cavities: 6
26.406.13.0065



Petal

Size: 98 x 38 h 48 mm
Volume: 94 ml Cavities: 8
26.394.13.0065





Mini Love Story

Size: 80 x 66 h 12 mm
Volume: 35 ml Cavities: 8
26.395.13.0065



Double use cutter



Mini Dress

Size: Ø 70 h 30 mm
Volume: 96 ml Cavities: 6
26.377.13.0065



Igloo¹¹⁵

Size: Ø 76 h 42 mm
Volume: 115 ml Cavities: 6
36.201.87.0065



Snowflakes

Size: Ø 56 h 35 mm
Volume: 60 ml Cavities: 11
26.115.87.0065





Cream

Size: Ø 73 h 65 mm
Volume: 120 ml Cavities: 6
26.343.13.0065



Mini Eleganza

Size: 70 x 70 h 30 mm
Volume: 100 ml Cavities: 6
26.212.13.0065



Mini Puff

Size: Ø 40 h 40 mm
Volume: 40 ml Cavities: 14
26.339.13.0065





Mini Color

Size: Ø 73 h 30 mm
Volume: 115 ml Cavities: 6
26.338.13.0065



Mini Dot

Size: Ø 70 h 30 mm
Volume: 90 ml Cavities: 6
26.265.13.0065



Puff

Size: Ø 62 h 52 mm
Volume: 125 ml Cavities: 8
26.334.13.0065





Mini Gemma

Size: Ø 68 h 42 mm
 Volume: 110 ml Cavities: 6
26.246.13.0065



Mini Intreccio

Size: Ø 75 h 35 mm
 Volume: 105 ml Cavities: 6
26.290.13.0065



Swing

Size: 80 x 45 h 35 mm
 Volume: 95 ml Cavities: 6
26.315.13.0065





Coccola

Size: Ø 70 h 55 mm
 Volume: 130 ml Cavities: 6
 26.305.13.0065



Dolce Tartufo

Size: Ø 62 h 52 mm
 Volume: 120 ml Cavities: 8
 26.192.13.0065



Mini Raggio

Size: Ø 67 h 33 mm
 Volume: 85 ml Cavities: 6
 26.233.13.0065



Kit Pop Éclair

Base Size: 130 x 38 h 28 mm
 Top Size: 109 x 24 h 12 mm
 Volume Base: 120 ml Cavities: 6
 Volume Top: 22 ml Cavities: 6
25.275.13.0065

Set: 2 Silicone moulds

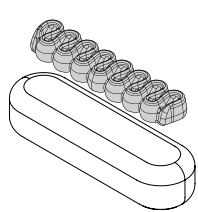

As a decoration
Decorazione

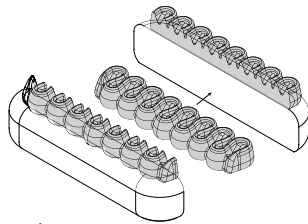

As an insert
Inserto



Base

Top

Kit Chic Éclair

Base Size: 130 x 38 h 28 mm
 Top Size: 117 x 18 h 16 mm
 Volume Base: 120 ml Cavities: 6
 Volume Top: 22 ml Cavities: 6
25.284.13.0065

Set: 2 Silicone moulds

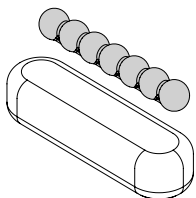

As a decoration
Decorazione

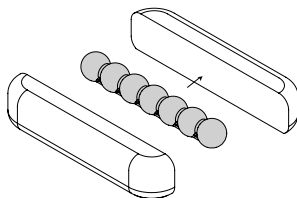

As an insert
Inserto

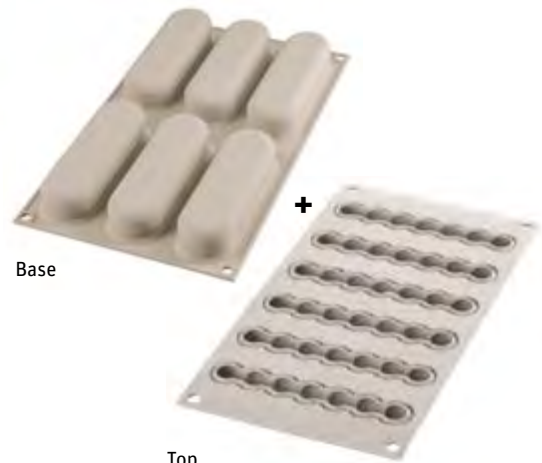

Base

Top



Mini Goccia

Size: Ø 68 h 33 mm
Volume: 88 ml Cavities: 6
26.234.13.0065



Bollicine

Size: Ø 70 h 30 mm
Volume: 85 ml Cavities: 6
26.270.13.0065



Soffice Incanto

Size: Ø 60 h 70 mm
Volume: 100 ml Cavities: 6
26.271.13.0065





Mosaico

Size: 50 x 50 h 50 mm
Volume: 105 ml Cavities: 9
26.292.13.0065



Mini Girotondo

Size: Ø 68 h 37 mm
Volume: 100 ml Cavities: 6
26.211.13.0065



Cuoricino

Size: 65 x 65 h 39 mm
Volume: 96 ml Cavities: 8
26.186.13.0065





Mini Ananas

Size: 58 x 100 h 38mm
Volume: 105 ml Cavities: 5
26.262.13.0065



Delizia al Limone

Size: 85 x 59 h 42 mm
Volume: 106 ml Cavities: 6
26.261.13.0065



Segreti del Bosco

Size: Ø 65 h 55 mm
Volume: 115 ml Cavities: 6
26.299.13.0065





Ispirazioni di Frutta

Size: Ø 62 h 52 mm
Volume: 118 ml Cavities: 6
26.300.13.0065



Fragole e Panna

Size: Ø 59 h 61 mm
Volume: 95 ml Cavities: 6
26.267.13.0065



Rosso Ciliegia

Size: 75 x 50 h 45 mm
Volume: 105 ml Cavities: 6
26.260.13.0065



THE NEW TRADITION

I CLASSICI



SF001 Half Sphere

Size: Ø 80 h 40 mm
Vol.: 120 ml - Cavities: 5

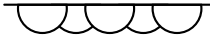
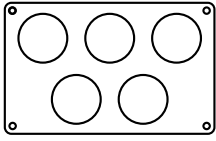

Bulk: 10.001.00.0000 - Polybag: 30.001.00.0060
Gift box: 20.001.00.0065

SF003 Half Sphere

Size: Ø 60 h 30 mm
Vol.: 60 ml - Cavities: 6

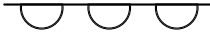
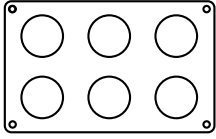

Bulk: 10.003.00.0000 - Polybag: 30.003.00.0060
Gift box: 20.003.00.0065

SF005 Half Sphere

Size: Ø 40 h 20 mm
Vol.: 20 ml - Cavities: 15

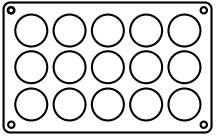

Bulk: 10.005.00.0000 - Polybag: 30.005.00.0060
Gift box: 20.005.00.0065

SF007 Pyramids

Size: 71 x 71 h 40 mm
Vol.: 90 ml - Cavities: 6

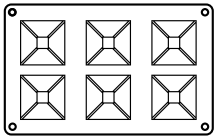

Bulk: 10.007.00.0000 - Polybag: 30.007.00.0060

SF009 Pomponnetes

Size: Ø 34 h 16 mm
Vol.: 18 ml - Cavities: 24

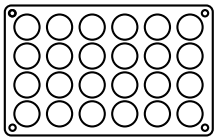

Bulk: 10.009.00.0000 - Polybag: 30.009.00.0060
Gift box: 20.009.00.0065

SF002 Half Sphere

Size: Ø 70 h 35 mm
Vol.: 80 ml - Cavities: 6

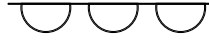
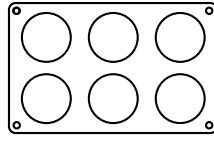

Bulk: 10.002.00.0000 - Polybag: 30.002.00.0060
Gift box: 20.002.00.0065

SF004 Half Sphere

Size: Ø 50 h 25 mm
Vol.: 30 ml - Cavities: 8

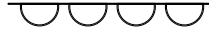
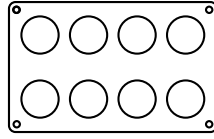

Bulk: 10.004.00.0000 - Polybag: 30.004.00.0060
Gift box: 20.004.00.0065

SF006 Half Sphere

Size: Ø 30 h 15 mm
Vol.: 10 ml - Cavities: 24

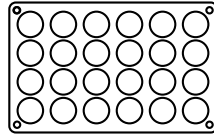

Bulk: 10.006.00.0000 - Polybag: 30.006.00.0060
Gift box: 20.006.00.0065

SF008 Pyramids

Size: 36 x 36 h 22 mm
Vol.: 20 ml - Cavities: 15

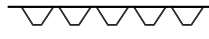
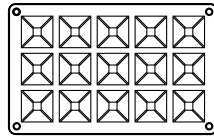

Bulk: 10.008.00.0000 - Polybag: 30.008.00.0060

SF010 Small Savarin

Size: Ø 41 h 12 mm
Vol.: 18 ml - Cavities: 18

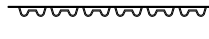
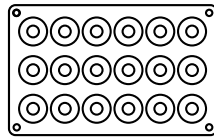

Bulk: 10.010.00.0000 - Polybag: 30.010.00.0060
Gift box: 20.010.00.0065

SF011 Medium Savarin

Size: Ø 65 h 21 mm
Vol.: 50 ml - Cavities: 8

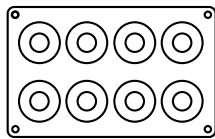

Bulk: 10.011.00.0000 - Polybag: 30.011.00.0060
Gift box: 20.011.00.0065

SF013 Tartelette

Size: Ø 45 h 10 mm
Vol.: 20 ml - Cavities: 15

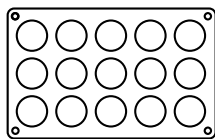

Bulk: 10.013.00.0000 - Polybag: 30.013.00.0060
Gift box: 20.013.00.0065

SF015 Tartelette

Size: Ø 60 h 17 mm
Vol.: 40 ml - Cavities: 8

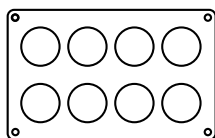

Bulk: 10.015.00.0000 - Polybag: 30.015.00.0060
Gift box: 20.015.00.0065

SF017 Small Ovals

Size: 55 x 33 h 20 mm
Vol.: 30 ml - Cavities: 16

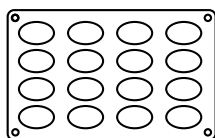

Bulk: 10.017.00.0000 - Polybag: 30.017.00.0060

SF019 Small Babà

Size: Ø 35 h 38 mm
Vol.: 30 ml - Cavities: 15

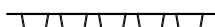
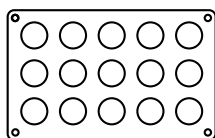

Bulk: 10.019.00.0000 - Polybag: 30.019.00.0060
Gift box: 20.019.00.0065

SF012 Big Savarin

Size: Ø 72 h 23 mm
Vol.: 62 ml - Cavities: 6

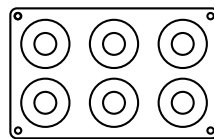

Bulk: 10.012.00.0000 - Polybag: 30.012.00.0060
Gift box: 20.012.00.0065

SF014 Tartelette

Size: Ø 50 h 15 mm
Vol.: 25 ml - Cavities: 15

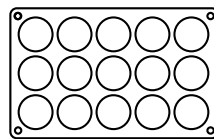

Bulk: 10.014.00.0000 - Polybag: 30.014.00.0060
Gift box: 20.014.00.0065

SF016 Tartelette

Size: Ø 70 h 20 mm
Vol.: 70 ml - Cavities: 6

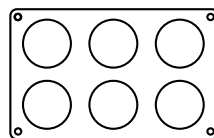

Bulk: 10.016.00.0000 - Polybag: 30.016.00.0060
Gift box: 20.016.00.0065

SF018 Medium Ovals

Size: 70 x 50 h 20 mm
Vol.: 50 ml - Cavities: 9

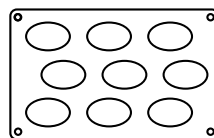

Bulk: 10.018.00.0000 - Polybag: 30.018.00.0060

SF020 Medium Babà

Size: Ø 45 h 48 mm
Vol.: 50 ml - Cavities: 11

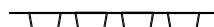
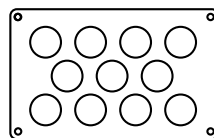

Bulk: 10.020.00.0000 - Polybag: 30.020.00.0060

SF021 Big Babà

Size: Ø 55 h 60 mm
Vol.: 92 ml - Cavities: 8

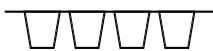
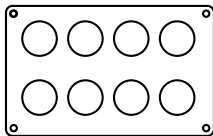

Bulk: 10.021.00.0000 - Polybag: 30.021.00.0060
Gift box: 20.021.00.0065

SF023 Medium Muffin

Size: Ø 69 h 35 mm
Vol.: 100 ml - Cavities: 6

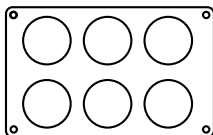

Bulk: 10.023.00.0000 - Polybag: 30.023.00.0060
Gift box: 20.023.00.0065

SF025 Financiers

Size: 49 x 26 h 11 mm
Vol.: 20 ml - Cavities: 20

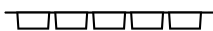
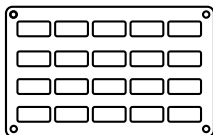

Bulk: 10.025.00.0000 - Polybag: 30.025.00.0060
Gift box: 20.025.00.0065

SF027 Petit Fours

Size: Ø 40 h 20 mm
Vol.: 30 ml - Cavities: 15

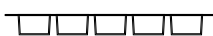
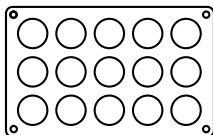

Bulk: 10.027.00.0000 - Polybag: 30.027.00.0060
Gift box: 20.027.00.0065

SF029 Florentins

Size: Ø 60 h 12 mm
Vol.: 35 ml - Cavities: 8

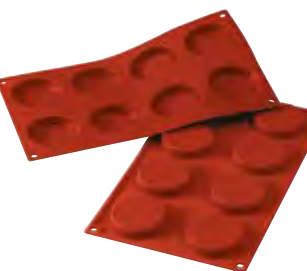
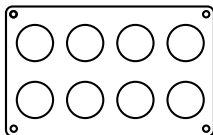

Bulk: 10.029.00.0000 - Polybag: 30.029.00.0060
Gift box: 20.029.00.0065

SF022 Small Muffin

Size: Ø 51 h 28 mm
Vol.: 50 ml - Cavities: 11

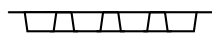
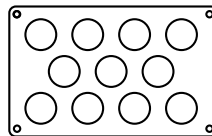

Bulk: 10.022.00.0000 - Polybag: 30.022.00.0060
Gift box: 20.022.00.0065

SF024 Big Muffin

Size: Ø 81 h 32 mm
Vol.: 135 ml - Cavities: 5

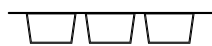
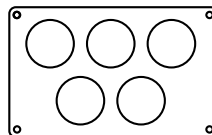

Bulk: 10.024.00.0000 - Polybag: 30.024.00.0060

SF026 Cakes

Size: 79 x 29 h 30 mm
Vol.: 70 ml - Cavities: 12

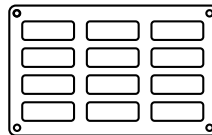

Bulk: 10.026.00.0000 - Polybag: 30.026.00.0060
Gift box: 20.026.00.0065

SF028 Cylinders

Size: Ø 60 h 35 mm
Vol.: 90 ml - Cavities: 8

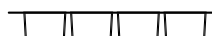
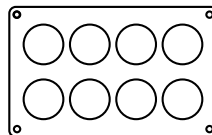

Bulk: 10.028.00.0000 - Polybag: 30.028.00.0060
Gift box: 20.028.00.0065

SF030 Mini Florentins

Size: Ø 35 h 5 mm
Vol.: 5 ml - Cavities: 24

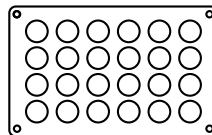

Bulk: 10.030.00.0000 - Polybag: 30.030.00.0060
Gift box: 20.030.00.0065

SF031 Mini Madeleine

Size: 44 x 34 h 10 mm
Vol.: 10 ml - Cavities: 15

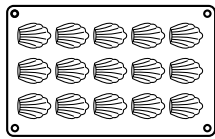

Bulk: 10.031.00.0000 - Polybag: 30.031.00.0060
Gift box: 20.031.00.0065

SF033 Small Bordelais

Size: Ø 35 h 35 mm
Vol.: 30 ml - Cavities: 18

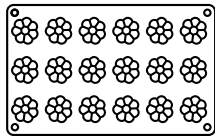

Bulk: 10.033.00.0000 - Polybag: 30.033.00.0060
Gift box: 20.033.00.0065

SF035 Briochette

Size: Ø 79 h 30 mm
Vol.: 110 ml - Cavities: 6

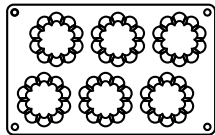

Bulk: 10.035.00.0000 - Polybag: 30.035.00.0060
Gift box: 20.035.00.0065

SF037 Octagons

Size: Ø 38 h 26 mm
Vol.: 30 ml - Cavities: 15

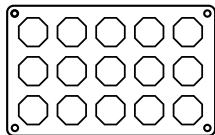

Bulk: 10.037.00.0000 - Polybag: 30.037.00.0060

SF039 Big Boat

Size: 100 x 44 h 15 mm
Vol.: 40 ml - Cavities: 9

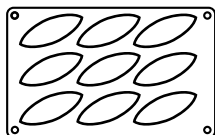

Bulk: 10.039.00.0000 - Polybag: 30.039.00.0060
Gift box: 20.039.00.0065

SF032 Madeleine

Size: 68 x 45 h 17 mm
Vol.: 30 ml - Cavities: 9

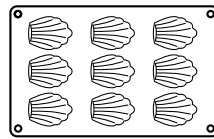

Bulk: 10.032.00.0000 - Polybag: 30.032.00.0060
Gift box: 20.032.00.0065

SF034 Briochette

Size: Ø 79 h 37 mm
Vol.: 110 ml - Cavities: 6

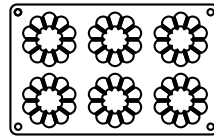

Bulk: 10.034.00.0000 - Polybag: 30.034.00.0060
Gift box: 20.034.00.0065

SF036 Heart

Size: Ø 65 h 40 mm
Vol.: 130 ml - Cavities: 6

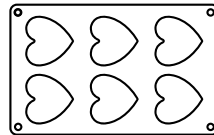

Bulk: 10.036.00.0000 - Polybag: 30.036.00.0060

SF038 Medium Boat

Size: 72 x 30 h 15 mm
Vol.: 20 ml - Cavities: 12

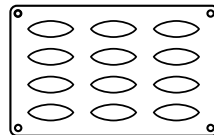

Bulk: 10.038.00.0000 - Polybag: 30.038.00.0060

SF040 Heart

Size: Ø 60 h 35 mm
Vol.: 90 ml - Cavities: 8

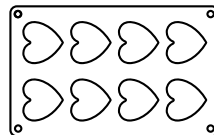

Bulk: 10.040.00.0000 - Polybag: 30.040.00.0060
Gift box: 20.040.00.0065

SF041 Half Egg

Size: 102 x 73 h 36 mm
Vol.: 130 ml - Cavities: 5

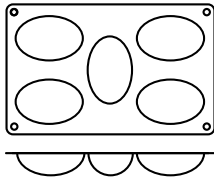

Bulk: 10.041.00.0000 - Polybag: 30.041.00.0060
Gift box: 20.041.00.0065



SF043 Flan Mould

Size: Ø 40 h 13 mm
Vol.: 20 ml - Cavities: 15

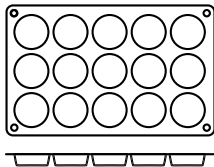

Bulk: 10.043.00.0000 - Polybag: 30.043.00.0060
Gift box: 20.043.00.0065



SF045 Flan Mould

Size: Ø 60 h 17 mm
Vol.: 42 ml - Cavities: 8

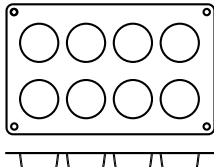

Bulk: 10.045.00.0000 - Polybag: 30.045.00.0060



SF047 Flan Mould

Size: Ø 80 h 18 mm
Vol.: 72 ml - Cavities: 6

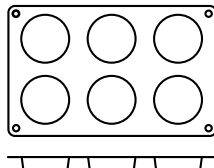

Bulk: 10.047.00.0000 - Polybag: 30.047.00.0060
Gift box: 20.047.00.0065



SF049 Big Diamond

Size: Ø 68 h 45 mm
Vol.: 92 ml - Cavities: 6

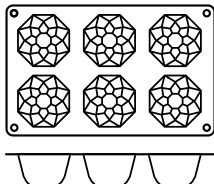

Bulk: 10.049.00.0000 - Polybag: 30.049.00.0060



SF042 Sponge Base

Size: Ø 103 h 20 mm
Vol.: 140 ml - Cavities: 3

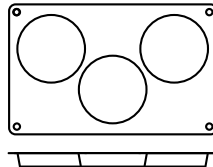

Bulk: 10.042.00.0000 - Polybag: 30.042.00.0060



SF044 Flan Mould

Size: Ø 50 h 14 mm
Vol.: 30 ml - Cavities: 15

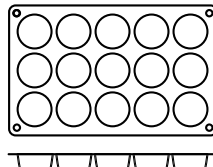

Bulk: 10.044.00.0000 - Polybag: 30.044.00.0060
Gift box: 20.044.00.0065



SF046 Flan Mould

Size: Ø 70 h 17 mm
Vol.: 52 ml - Cavities: 6

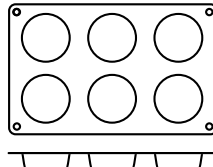

Bulk: 10.046.00.0000 - Polybag: 30.046.00.0060



SF048 Small Diamond

Size: Ø 35 h 23 mm
Vol.: 20 ml - Cavities: 18

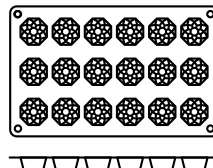

Bulk: 10.048.00.0000 - Polybag: 30.048.00.0060
Gift box: 20.048.00.0065



SF050 Big Bordelais

Size: Ø 55 h 50 mm
Vol.: 92 ml - Cavities: 8

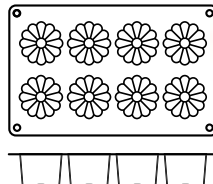

Bulk: 10.050.00.0000 - Polybag: 30.050.00.0060
Gift box: 20.050.00.0065



SF051 Bavarese

Size: Ø 57 h 57 mm
Vol.: 130 ml - Cavities: 8

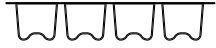
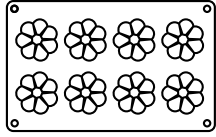

Bulk: 10.051.00.0000 - Polybag: 30.051.00.0060
Gift box: 20.051.00.0065

SF053 Krapfen

Size: Ø 60 h 20 mm
Vol.: 40 ml - Cavities: 8

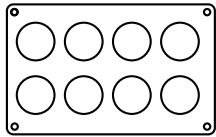

Bulk: 10.053.00.0000 - Polybag: 30.053.00.0060

SF055 Big Ovals

Size: 75 x 55 h 35 mm
Vol.: 110 ml - Cavities: 8

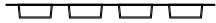
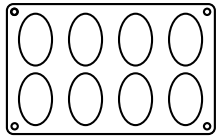

Bulk: 10.055.00.0000 - Polybag: 30.055.00.0060
Gift box: 20.055.00.0065

SF057 Mini Gugelhopf

Size: Ø 55 h 36 mm
Vol.: 50 ml - Cavities: 8

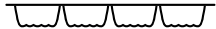
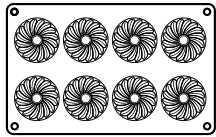

Bulk: 10.057.00.0000 - Polybag: 30.057.00.0060

SF059 Medium Bordelais

Size: Ø 45 h 45 mm
Vol.: 60 ml - Cavities: 15

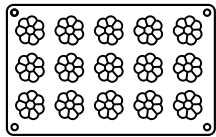

Bulk: 10.059.00.0000 - Polybag: 30.059.00.0060
Gift box: 20.059.00.0065

SF052 Big Muffin

Size: Ø 75 h 60 mm
Vol.: 165 ml - Cavities: 6

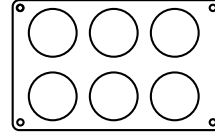

Bulk: 10.052.00.0000 - Polybag: 30.052.00.0060
Gift box: 20.052.00.0065

SF054 Big Financiers

Size: 95 x 45 h 12 mm
Vol.: 50 ml - Cavities: 7

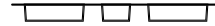
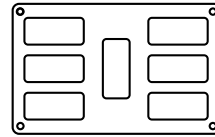

Bulk: 10.054.00.0000 - Polybag: 30.054.00.0060
Gift box: 20.054.00.0065

SF056 Daisy

Size: Ø 70 h 28 mm
Vol.: 80 ml - Cavities: 6

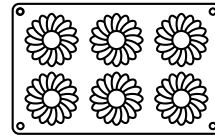

Bulk: 10.056.00.0000 - Polybag: 30.056.00.0060
Gift box: 20.056.00.0065

SF058 Gugelhopf

Size: Ø 70 h 36 mm
Vol.: 80 ml - Cavities: 6

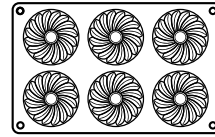

Bulk: 10.058.00.0000 - Polybag: 30.058.00.0060
Gift box: 20.058.00.0065

SF060 Nougats

Size: 50 x 25 h 20 mm
Vol.: 22 ml - Cavities: 20

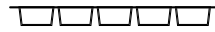
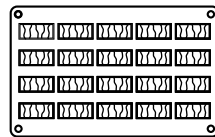

Bulk: 10.060.00.0000 - Polybag: 30.060.00.0060

SF061 Fantasy

Size: Ø 75 h 40 mm
Vol.: 100 ml - Cavities: 6

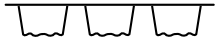
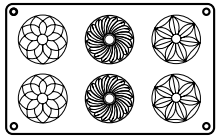

Bulk: 10.061.00.0000 - Polybag: 30.061.00.0060
Gift box: 20.061.00.0065

SF067 Kiss

Size: Ø 70 h 57 mm
Vol.: 183 ml - Cavities: 6

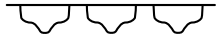
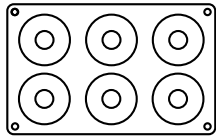

Bulk: 10.067.00.0000 - Polybag: 30.067.00.0060

SF072 Small Sunflower

Size: Ø 44 h 27 mm
Vol.: 23 ml - Cavities: 15

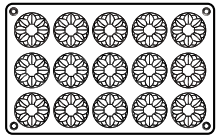

Bulk: 10.072.00.0000 - Polybag: 30.072.00.0060

SF075 Narcissus

Size: Ø 76 h 40 mm
Vol.: 115 ml - Cavities: 6

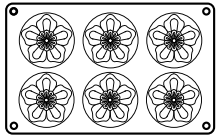

Bulk: 10.075.00.0000 - Polybag: 30.075.00.0060

SF077 Rose

Size: Ø 76 h 40 mm
Vol.: 115 ml - Cavities: 6

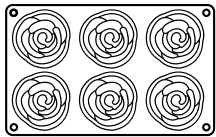

Bulk: 10.077.00.0000 - Polybag: 30.077.00.0060
Gift box: 20.077.00.0065

SF066 Barrette

Size: 200 x 157 h 13 mm
Volume: 361 ml



Bulk: 10.066.00.0000 - Polybag: 30.066.00.0060

SF071 Square Bar

Size: 300 x 300 h 20 mm
Volume: 1800 ml

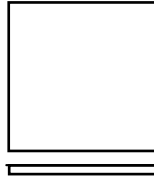

Bulk: 10.071.00.0000

SF074 Small Rose

Size: Ø 44 h 27 mm
Vol.: 23 ml - Cavities: 15

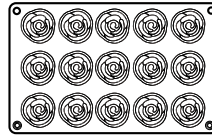

Bulk: 10.074.00.0000 - Polybag: 30.074.00.0060
Gift box: 20.074.00.0065

SF076 Sunflower

Size: Ø 76 h 40 mm
Vol.: 115 ml - Cavities: 6

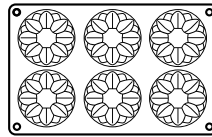

Bulk: 10.076.00.0000 - Polybag: 30.076.00.0060
Gift box: 20.076.00.0065

SF078 Dahlia

Size: Ø 78 h 40 mm
Vol.: 115 ml - Cavities: 6

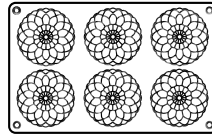

Bulk: 10.078.00.0000 - Polybag: 30.078.00.0060

SF080 Small Square Savarin

Size: 32,5 x 32,5 h 20 mm
Vol.: 16 ml - Cavities: 24

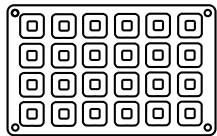

Bulk: 10.080.00.0000 - Polybag: 30.080.00.0060

SF081 Medium Square Savarin

Size: 45,5 x 45,5 h 28 mm
Vol.: 45 ml - Cavities: 15

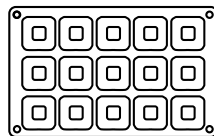

Bulk: 10.081.00.0000 - Polybag: 30.081.00.0060

SF082 Big Square Savarin

Size: 62,5 x 62,5 h 25 mm
Vol.: 73 ml - Cavities: 8

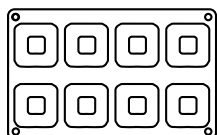

Bulk: 10.082.00.0000 - Polybag: 30.082.00.0060

SF083 Small Oval Savarin

Size: 41 x 29 h 20 mm
Vol.: 16 ml - Cavities: 24

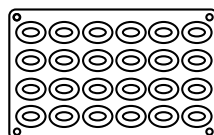

Bulk: 10.083.00.0000 - Polybag: 30.083.00.0060

SF084 Medium Oval Savarin

Size: 67 x 49 h 23 mm
Vol.: 48 ml - Cavities: 10

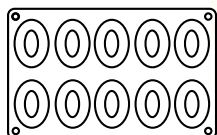

Bulk: 10.084.00.0000 - Polybag: 30.084.00.0060

SF085 Big Oval Savarin

Size: 74 x 57 h 27 mm
Vol.: 72 ml - Cavities: 8

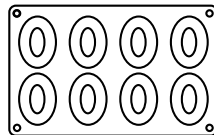

Bulk: 10.085.00.0000 - Polybag: 30.085.00.0060

SF086 Magic Dome

Size: Ø 75 h 40 mm
Vol.: 115 ml - Cavities: 6

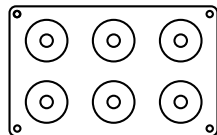

Bulk: 10.086.00.0000 - Polybag: 30.086.00.0060

SF087 Big passion

Size: 59x60 h 30 mm
Vol.: 72 ml - Cavities: 8

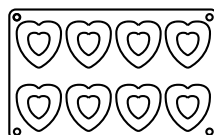

Bulk: 10.087.00.0000 - Polybag: 30.087.00.0060

SF088 Medium passion

Size: 48x54 h 27 mm
Vol.: 45 ml - Cavities: 10

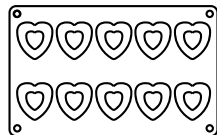

Bulk: 10.088.00.0000 - Polybag: 30.088.00.0060
Gift box: 20.088.00.0065

SF089 Small passion

Size: 33x35 h 22 mm
Vol.: 16 ml - Cavities: 24

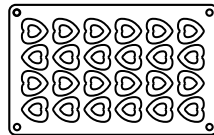

Bulk: 10.089.00.0000 - Polybag: 30.089.00.0060

SF090 Big Lingotto

Size: 72 x 45 h 26 mm
Vol.: 72 ml - Cavities: 8

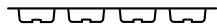
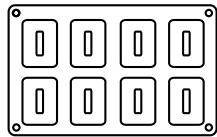

Bulk: 10.090.00.0000 - Polybag: 30.090.00.0060

SF092 Small Lingotto

Size: 41 x 23 h 21 mm
Vol.: 16 ml - Cavities: 25

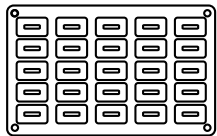

Bulk: 10.092.00.0000 - Polybag: 30.092.00.0060

SF095 Small Vulcano

Size: Ø 36 h 31 mm
Vol.: 16 ml - Cavities: 24

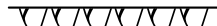
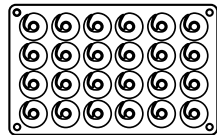

Bulk: 10.095.00.0000 - Polybag: 30.095.00.0060

SF100 Pandorino

Size: 75 x 75 h 60 mm
Vol.: 150 ml - Cavities: 6

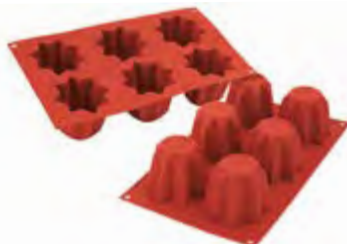
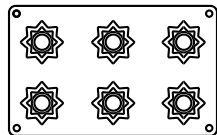

Bulk: 16.100.00.0000 - Polybag: 36.100.00.0060
Gift box: 26.100.00.0065

SF103 Savoiardo

Size: 127,5 x 47 h 17 mm
Vol.: 83 ml - Cavities: 6

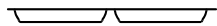
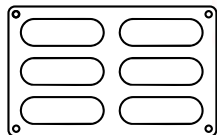

Bulk: 16.103.00.0000 - Polybag: 36.103.00.0060
Gift box: 26.103.00.0065

SF091 Medium Lingotto

Size: 58 x 37 h 25 mm
Vol.: 45 ml - Cavities: 10

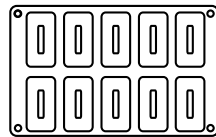

Bulk: 10.091.00.0000 - Polybag: 30.091.00.0060

SF093 Big Vulcano

Size: Ø 60 h 51 mm
Vol.: 72 ml - Cavities: 8

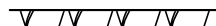
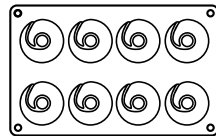

Bulk: 10.093.00.0000 - Polybag: 30.093.00.0060

SF098 Cylinders

Size: Ø 48 h 50 mm
Vol.: 83 ml - Cavities: 12

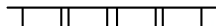
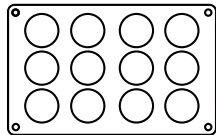

Bulk: 10.098.00.0000 - Polybag: 30.098.00.0060
Gift box: 20.098.00.0065

SF102 Medium Muffin

Size: Ø 68 h 38 mm
Vol.: 119 ml - Cavities: 6

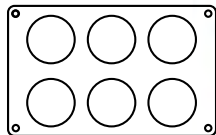

Bulk: 16.102.00.0000 - Polybag: 36.102.00.0060
Gift box: 26.102.00.0065

SF104 Cube

Size: 50 x 50 x 50 mm
Vol.: 125 ml - Cavities: 8

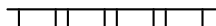
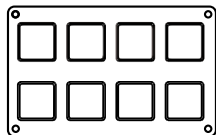

Bulk: 16.104.00.0000 - Polybag: 36.104.00.0060
Gift box: 26.104.00.0065

SF105 Cube

Size: 35 x 35 h 35 mm
Vol.: 42 ml - Cavities: 15

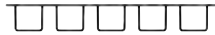
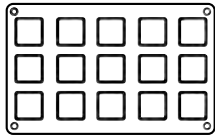

Bulk: 16.105.00.0000 - Polybag: 36.105.00.0060
Gift box: 26.105.00.0065

SF107 Stella

Size: Ø 70 h 25 mm
Vol.: 52,5 ml - Cavities: 8

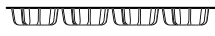
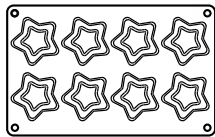

Bulk: 16.107.00.0000 - Polybag: 36.107.00.0060
Gift box: 26.107.00.0065

SF109 Mini Briochette

Size: Ø 58 h 22 mm
Vol.: 33 ml - Cavities: 12

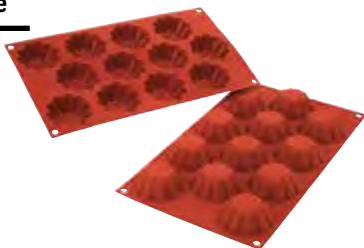
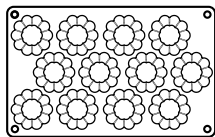

Bulk: 16.109.00.0000 - Polybag: 36.109.00.0060
Gift box: 26.109.00.0065

SF111 Ovals

Size: 88 x 53 h 24 mm
Vol.: 85 ml - Cavities: 6

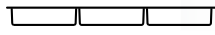
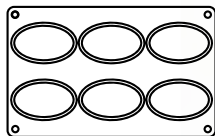

Bulk: 16.111.00.0000 - Polybag: 36.111.00.0060

SF113 Flu

Size: Ø 55 h 42,5 mm
Vol.: 70 ml - Cavities: 8

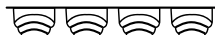
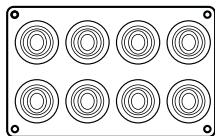

Bulk: 16.113.00.0000 - Polybag: 36.113.00.0060
Gift box: 26.113.00.0065

SF106 Gingerbread Man

Size: 94,5 x 78 h 21 mm
Vol.: 60 ml - Cavities: 6

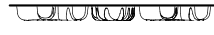
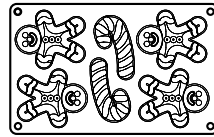

Bulk: 16.106.00.0000 - Polybag: 36.106.00.0060
Gift box: 26.106.00.0065

SF108 Pino

Size: 83,5 x 68 h 30,5 mm
Vol.: 81 ml - Cavities: 8

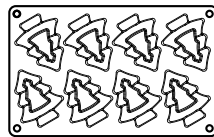

Bulk: 16.108.00.0000 - Polybag: 36.108.00.0060
Gift box: 26.108.00.0065

SF110 Rettangolo

Size: 87 x 48 h 24 mm
Vol.: 97 ml - Cavities: 7

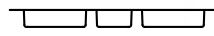
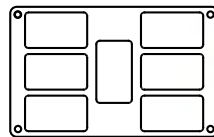

Bulk: 16.110.00.0000 - Polybag: 36.110.00.0060
Gift box: 26.110.00.0065

SF112 Colombine

Size: 91x73 h 28,5 mm
Vol.: 122 ml - Cavities: 6

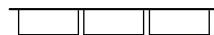
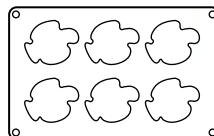

Bulk: 16.112.00.0000

SF114 Marsigliese

Size: 95 x 35 h 25 mm
Vol.: 68 ml - Cavities: 7

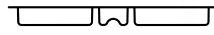
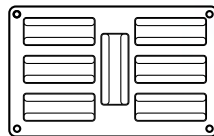

Bulk: 16.114.00.0000 - Polybag: 36.114.00.0060

SF116 Halloween

Size: 70 x 64 h 32 mm
Vol.: 71,5 ml - Cavities: 8

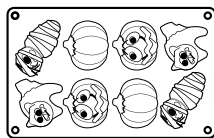

Bulk: 16.116.00.0000 - Polybag: 36.116.00.0060

SF119 Cylinders

Size: Ø 63 h 40 mm
Vol.: 123 ml - Cavities: 8

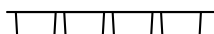
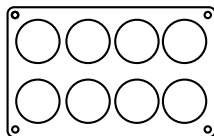

Bulk: 16.119.00.0000 - Polybag: 36.119.00.0060
Gift box: 26.119.00.0065

SF125 Choco Giandua

Size: 50 x 18 h 23 mm
Vol.: 14 ml - Cavities: 24

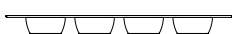
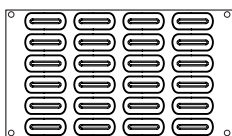

Bulk: 16.125.00.0000 - Polybag: 36.125.00.0060
Box: 36.125.00.0065

SF127 Cylinders

Size: Ø 70 h 35 mm
Vol.: 133 ml - Cavities: 6

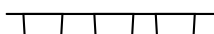
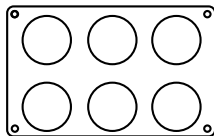

Bulk: 16.127.00.0000 - Polybag: 36.127.00.0060
Gift box: 26.127.00.0065

SF129 Mini Bûche

Size: 44 x 18 h 20 mm
Vol.: 14 ml - Cavities: 30

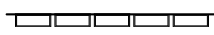
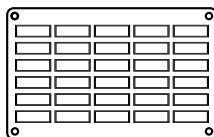

Bulk: 16.129.00.0000 - Polybag: 36.129.00.0060

SF117 Springlife

Size: 77 x 57 h 32 mm
Vol.: 81 ml - Cavities: 8

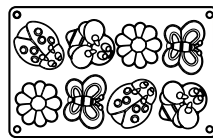

Bulk: 16.117.00.0000 - Polybag: 36.117.00.0060
Gift box: 26.117.00.0065

SF124 Passion

Size: 70x72 h 40 mm
Vol.: 125 ml - Cavities: 6

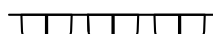
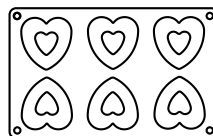

Bulk: 16.124.00.0000 - Polybag: 25.124.00.0060

SF126 Gianduiotto

Size: 93 x 31 h 42 mm
Vol.: 85 ml - Cavities: 9

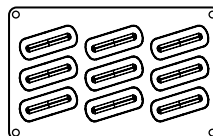

Bulk: 16.126.00.0000 - Polybag: 36.126.00.0060
Box: 36.126.00.0065

SF128 Slim

Size: 120 x 45 h 20 mm
Vol.: 110 ml - Cavities: 6

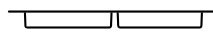

Bulk: 16.128.00.0000 - Polybag: 36.128.00.0060

SF130 Midi Bûche

Size: 84 x 32 h 35 mm
Vol.: 83 ml - Cavities: 9

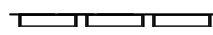
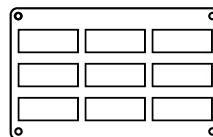

Bulk: 36.130.00.0065 - Polybag: 16.130.00.0000
Box: 36.130.00.0065

SF131 Cono

Size: Ø 18 h 30 mm
Vol.: 3 ml - Cavities: 66

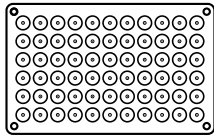

Bulk: 16.131.00.0000 - Polybag: 36.131.00.0060
Gift box: 26.131.00.0065

SF135 Mini Springlife

Size: 50 x 38 h 20 mm
Vol.: 20 ml - Cavities: 15

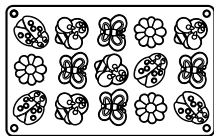

Bulk: 16.135.00.0000 - Polybag: 36.135.00.0060

SF143 Mini Waffel Round

Size: Ø 40 h 12 mm
Vol.: 11,5 ml - Cavities: 18

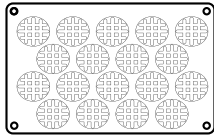

Bulk: 16.143.00.0000 - Box: 36.143.00.0065

SF145 Cicala

Size: 71 x 41 h 22 mm
Vol.: 35 ml - Cavities: 8

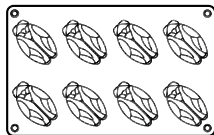

Bulk: 16.145.00.0000 - Polybag: 36.145.00.0060

SF148 Mini Wonder Cake

Size: Ø 75 h 60 mm
Vol.: 177 ml - Cavities: 6

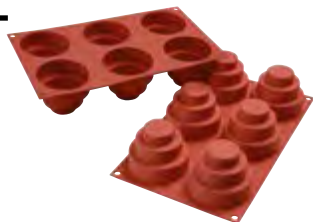
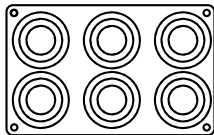

Bulk: 16.148.00.0000 - Polybag: 36.148.00.0060

SF132 Mini Fantasy

Size: Ø 40 h 22 mm
Vol.: 17,5 ml - Cavities: 18

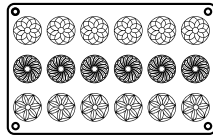

Bulk: 16.132.00.0000 - Polybag: 36.132.00.0060
Gift box: 26.132.00.0065

SF141 Choco Panda

Size: Ø 36 h 18 mm
Vol.: 8,5 ml - Cavities: 24

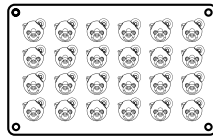

Bulk: 16.141.00.0000 - Polybag: 36.141.00.0060

SF144 Tribon

Size: 124x40 h 30 mm
Vol.: 117 ml - Cavities: 6

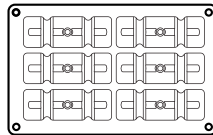

Bulk: 16.144.00.0000 - Polybag: 36.144.00.0060

SF147 Mini Waffel Square

Size 45 x 35 h 10 mm
Vol.: 20 ml - Cavities: 20

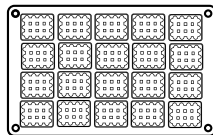

Bulk: 16.147.00.0000 - Box: 36.147.00.0065

SF151 Flash

Size: Ø 63 h 5 mm
Vol.: 8,3 ml - Cavities: 11

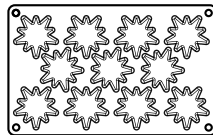

Bulk: 16.151.00.0000 - Polybag: 36.151.00.0060

SF154 Charlotte

Size: Ø 70 h 41 mm
Vol.: 102 ml - Cavities: 8

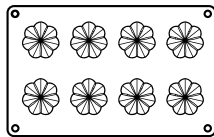

Bulk: 16.154.00.0000 - Polybag: 36.154.00.0060
Gift box: 26.154.00.0065

SF158 Vertigo

Size: Ø 77 h 37 mm
Vol.: 110 ml - Cavities: 6

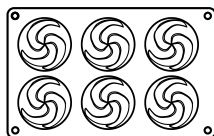

Bulk: 16.158.00.0000 - Polybag: 36.158.00.0060

SF167 Mr. Zeny

Size: 70 x 58 h 16 mm
Volume: 22 ml - Cavities: 12

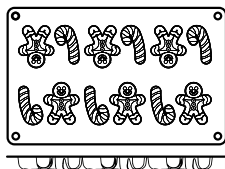

Bulk: 16.167.00.0000

SF170 Donuts

Size: Ø 75-25 h 28 mm
Vol.: 98 ml - Cavities: 6

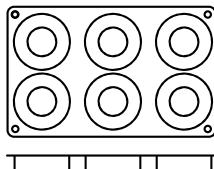

Bulk: 16.170.00.0000 - Box: 36.170.00.0065
Polybag: 36.170.00.0060

SF174 Choco 123

Volume Tot.: 124 ml
Cavities: 60

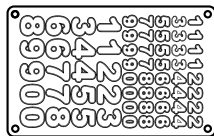

Bulk: 16.174.00.0000 - Polybag: 36.174.00.0060

SF155 Waffel Classic

Size: 130 x 81 h 17 mm
Vol.: 137 ml - Cavities: 4

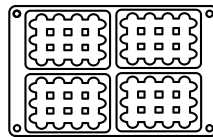

Bulk: 16.155.00.0000 - Polybag: 36.155.00.0060
Gift box: 36.155.00.0065

SF162 Round Délice

Size: Ø 40 h 25 mm
Vol.: 29 ml - Cavities: 15

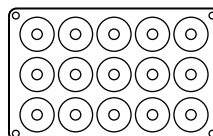

Bulk: 16.162.00.0000 - Polybag: 36.162.00.0060

SF169 Choco ABC

Volume Tot.: 115 ml
Cavities: 81

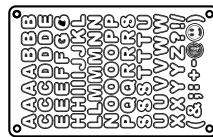

Bulk: 16.169.00.0000 - Polybag: 36.169.00.0060

SF171 Mini Donuts

Size: Ø 45-15 h 18 mm
Vol.: 22 ml - Cavities: 15

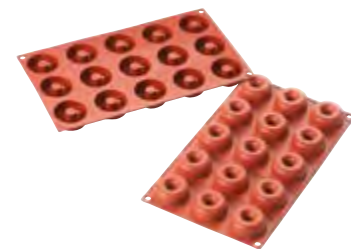
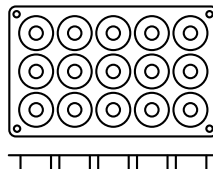

Bulk: 16.171.00.0000 - Box: 36.171.00.0065
Polybag: 36.171.00.0060

SF175 Square Delice

Size: 35 x 35 h 25 mm
Vol.: 26,3 ml - Cavities: 15

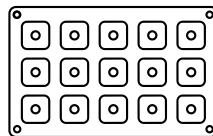

Bulk: 16.175.00.0000 - Polybag: 36.175.00.0060

SF176 Soft Ovals

Size: 60 x 30 h 26 mm
Vol.: 88 ml - Cavities: 16

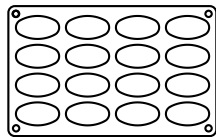

Bulk: 16.176.00.0000 - Polybag: 36.176.00.0060
Gift box: 26.176.00.0065

SF178 Mini Dessert Round

Size: \varnothing 40 h 13 mm
Vol.: 12 ml - Cavities: 15

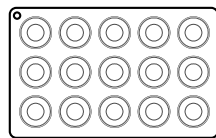

Bulk: 16.178.00.0000 - Polybag: 36.178.00.0060

SF180 Pastille

Size: \varnothing 28 h 11 mm
Vol.: 6 ml - Cavities: 40

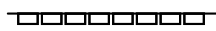
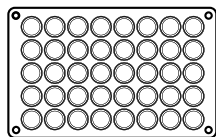

Bulk: 16.180.00.0000 - Polybag: 36.180.00.0060

SF182 Stars

Size: \varnothing 45 h 22 mm
Vol.: 19 ml - Cavities: 18

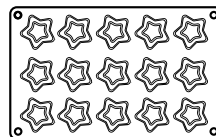

Bulk: 16.182.00.0000

SF190 Mini Gufi

Size: 36 x 42 h 22 mm
Vol.: 20.5 ml - Cavities: 18

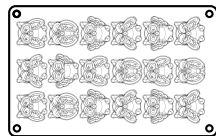

Bulk: 16.190.00.0000 - Polybag: 36.190.00.0060

SF177 Mini Dessert Square

Size: 38 x 38 h 13 mm
Vol.: 14 ml - Cavities: 15

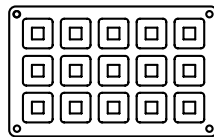

Bulk: 16.177.00.0000 - Polybag: 36.177.00.0060

SF179 Mini Dessert Oval

Size: 60 x 24 h 23 mm
Vol.: 26 ml - Cavities: 20

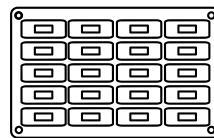

Bulk: 16.179.00.0000 - Polybag: 36.179.00.0060

SF181 Mini Cakes

Size: 30 x 18 h 16 mm
Vol.: 7,5 ml - Cavities: 30

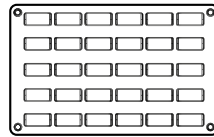

Bulk: 16.181.00.0000 - Polybag: 36.181.00.0060

SF184 Slim Bar

Size: 100 x 26 h 16 mm
Vol.: 40 ml - Cavities: 8

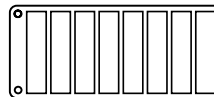

Bulk: 16.184.00.0000 - Box: 36.184.00.0065
Polybag: 36.184.00.0060

SF191 Gufi

Size: 74 x 66 h 33,5 mm
Vol.: 84 ml - Cavities: 8

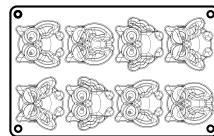

Bulk: 16.191.00.0000 - Polybag: 36.191.00.0060

SF199 Funny Owls Choco Tags

Size: 60 x 37 h 8 mm
Vol.: 10 ml - Cavities: 16

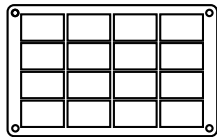

Bulk: 16.199.00.0000 - Polybag: 36.199.00.0060

SF205 Cylinders

Size: Ø 70 h 27 mm
Vol.: 103 ml - Cavities: 6

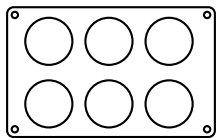

Bulk: 16.205.00.0000 - Polybag: 36.205.00.0060

SF209 Gugelhopf

Size: Ø 75 h 40 mm
Vol.: 100 ml - Cavities: 6

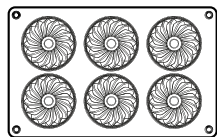

Bulk: 16.209.00.0000 - Polybag: 36.209.00.0060

SF263 Small Cube

Size: 24 x 24 h 24 mm
Vol.: 13 ml - Cavities: 40

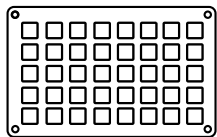

Bulk: 16.263.00.0000 - Polybag: 36.263.00.0060

SF326 Biscotti

Size: 57x23 h 25 mm
Vol.: 47,5 ml - Cavities: 12

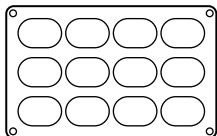

Bulk: 16.326.00.0000 - Polybag: 36.326.00.0060

SF204 Mini Cylinders

Size: Ø 50 h 27 mm
Vol.: 55 ml - Cavities: 11

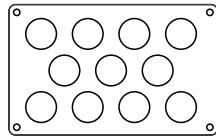

Bulk: 16.204.00.0000 - Polybag: 36.204.00.0060

SF208 Fancy Toys

Size: 60 x 30 h 20 mm
Vol.: 22 ml - Cavities: 15

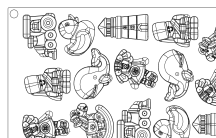

Item available upon specific request, subject to minimum quantities.
Articolo disponibile solo su ordinazione, soggetti a quantità minime.



Bulk: 16.208.00.0000

SF232 Gugelhopf

Size: Ø 35 h 20 mm
Vol.: 10 ml - Cavities: 24

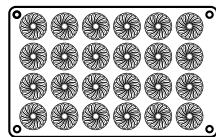

Bulk: 16.232.00.0000 - Polybag: 36.232.00.0060
Gift box: 26.232.00.0065

SF310 Swirl

Size: Ø 47.5 h 20 mm
Vol.: 16 ml - Cavities: 15



Bulk: 16.310.00.0000 - Polybag: 36.310.00.0060

SF351

Size: 38x38/30x30 h 15 mm
Vol.: 18 ml - Cavities: 24

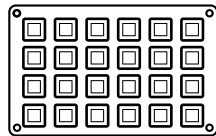

Bulk: 16.351.00.0000 - Polybag: 36.351.00.0060

SF378 Mauresque Round

Size: Ø 40 h 16 mm
Vol.: 19 ml - Cavities: 15

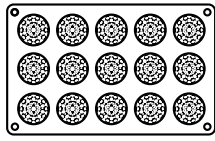

Bulk: 16.378.00.0000 - Polybag: 36.378.00.0060

SF535 Half Sphere

Size: Ø 35 h 19 mm
Vol.: 13 ml - Cavities: 24

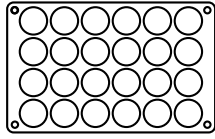

Bulk: 16.535.00.0000 - Polybag: 36.535.00.0060

SF555 Half Sphere

Size: Ø 55 h 29 mm
Vol.: 46 ml - Cavities: 8

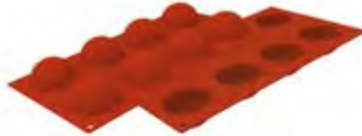
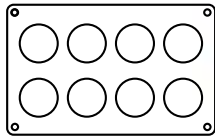

Bulk: 16.555.00.0000 - Polybag: 36.555.00.0060

ANSF - Safe Ring

Size: 173 x 300 mm



Bulk: 50.000.00.0000

SF379 Mauresque Square

Volume: 40 x 40 h 16 mm
Vol.: 23 ml - Cavities: 15

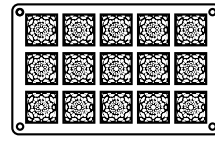

Bulk: 16.379.00.0000 - Polybag: 36.379.00.0060

SF545 Half Sphere

Size: Ø 45 h 24 mm
Vol.: 27 ml - Cavities: 15

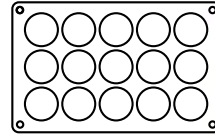

Bulk: 16.545.00.0000 - Polybag: 36.545.00.0060

SF565 Half Sphere

Size: Ø 65 h 34 mm
Vol.: 75 ml - Cavities: 8

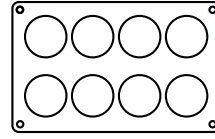

Bulk: 16.565.00.0000 - Polybag: 36.565.00.0060

Round Pan



SFT118 Round Pan

Size: Ø 180 h 40 mm
Volume: 1000 ml
Bulk: 20.118.00.0000
Polybag: 30.118.00.0060

SFT120 Round Pan

Size: Ø 200 h 40 mm
Volume: 1050 ml
Bulk: 20.120.00.0000
Polybag: 30.120.00.0060

SFT122 Round Pan

Size: Ø 220 h 42 mm
Volume: 1400 ml
Bulk: 20.122.00.0000
Polybag: 30.122.00.0060

SFT124 Round Pan

Size: Ø 240 h 47 mm
Volume: 1700 ml
Bulk: 20.124.00.0000
Polybag: 30.124.00.0060

SFT126 Round Pan

Size: Ø 260 h 45 mm
Volume: 2200 ml
Bulk: 20.126.00.0000
Polybag: 30.126.00.0060
Box: 20.126.00.0065

SFT128 Round Pan

Size: Ø 280 h 47 mm
Volume: 2500 ml
Bulk: 20.128.00.0000
Polybag: 30.128.00.0060

SFT180 Round Pan

Size: Ø 180 h 65 mm
Volume: 1500 ml
Bulk: 20.180.00.0000
Polybag: 30.180.00.0060
Box 20.180.00.0065

SFT226 Round Pan

Size: Ø 260 h 55 mm
Volume: 2500 ml
Bulk: 20.226.00.0000
Polybag: 30.226.00.0060

SFT228 Pizza Pan

Size: Ø 280 h 20 mm
Volume: 1300 ml
Bulk: 10.228.00.0000
Polybag: 30.228.00.0060



Rectangular Cake



SFT300 Bake & Roast

Size: 280x220 h 40 mm
Volume: 1300 ml
Bulk: 20.300.00.0000
Polybag: 30.300.00.0060

SFT306 Square Pan

Size: 228x228 h 50 mm
Volume: 2300 ml
Bulk: 20.306.00.0000
Polybag: 30.306.00.0060

SFT332 Lasagnera

Size: 330x220 h 55 mm
Volume: 4500 ml
Bulk: 20.332.00.0000

Flan Pan



SFT424 Flan Pan

Size: Ø 240 h 30 mm
Volume: 1250 ml
Bulk: 20.424.00.0000
Polybag: 30.424.00.0060

SFT426 Flan Pan

Size: Ø 260 h 30 mm
Volume: 1300 ml
Bulk: 20.426.00.0000
Polybag: 30.426.00.0060
Gift Box: 20.426.00.0065

SFT428 Flan Pan

Size: Ø 280 h 30 mm
Volume: 1750 ml
Bulk: 20.428.00.0000
Polybag: 30.428.00.0060

Plum Cake



SFT326 Plum Cake

Size: 240x105 h 65 mm
Volume: 1500 ml
Bulk: 20.326.00.0000
Polybag: 30.326.00.0060

SFT 330 Plum Cake

Size: 260x100 h 70 mm
Volume: 1550 ml
Bulk: 20.330.00.0000
Polybag: 30.330.00.0060
Gift Box: 20.330.00.0065

SFT331 Plum Cake

Size: 300x100 h 70 mm
Volume: 1700 ml
Bulk: 20.331.00.0000
Polybag: 30.331.00.0060

SFT181 Charlotte

Size: Ø 180 h 60 mm
Volume: 1,35 l
Bulk: 20.181.00.0000
Polybag: 30.181.00.0060



SFT201 Small Star

Size: Ø 260 h 40 mm
Volume: 1,2 l
Bulk: 20.201.00.0000
Polybag: 30.201.00.0060



SFT203 Tree

Size: 280 x 200 h 40 mm
Volume: 1,05 l
Bulk: 20.203.00.0000
Polybag: 30.203.00.0060



SFT205 Savarin

Size: Ø 240 h 55 mm
Volume: 1,55 l
Bulk: 20.205.00.0000
Polybag: 30.205.00.0060
Gift Box: 20.205.00.0065



SFT210 Heart

Size: 220 x 218 h 40 mm
Volume: 1,25 l
Bulk: 10.210.00.0000
Polybag: 30.210.00.0060



SFT211 Heart

Size: 205 x 186 h 54 mm
Volume: 1,1 l
Bulk: 10.211.00.0000
Polybag: 30.211.00.0060
Gift Box: 20.211.00.0065



SFT220 Daisy

Size: Ø 220 h 45 mm
Volume: 1,3 l
Bulk: 20.220.00.0000
Polybag: 30.220.00.0060



SFT224 Savarin Cake

Size: Ø 240 h 60 mm
Volume: 1,25 l
Bulk: 20.224.00.0000
Polybag: 30.224.00.0060



SFT249 Gugelhopf

Size: Ø 200 h 90 mm
Volume: 1,5 l
Bulk: 20.249.00.0000
Polybag: 30.249.00.0060



SFT250 Gugelhopf

Size: Ø 220 h 110 mm
Volume: 2,2 l
Bulk: 20.250.00.0000
Polybag: 30.250.00.0060



SFT251 Rose

Size: Ø 220 h 100 mm
Volume: 2,25 l
Bulk: 20.251.00.0000
Polybag: 30.251.00.0060
Gift box: 24.251.00.0065



SFT252 Sunflower

Size: Ø 260 h 70 mm
Volume: 2,25 l
Bulk: 20.252.00.0000
Polybag: 30.252.00.0060
Gift Box: 20.252.00.0065



SFT303 Cathedral

Size: Ø 220 h 100 mm
Volume: 2,2 l
Bulk: 14.303.00.0000
Gift Box: 24.303.00.0065



SFT322 Springlife

Size: Ø 200 h 90 mm
Volume: 1,8 l
Bulk: 20.322.00.0000
Polybag: 30.322.00.0060



SFT323 Tulip

Size: Ø 260 h 68 mm
Volume: 2,8 l
Bulk: 20.323.00.0000
Polybag: 30.323.00.0060



SFT336 Fairy Princess

Size: 28,5 x 14,5 h 40 mm
Volume: 950 ml
Bulk: 10.336.00.0000
Gift Box: 20.336.00.0065



SFT339 Goleador

Size: 242 x 230 h 40 mm
Volume: 1,2 L
Bulk: 10.339.00.0000
Gift Box: 20.339.00.0065



SFT522 Brioche

Size: Ø 220 h 80 mm
Volume: 1,7 l
Bulk: 20.522.00.0000
Polybag: 30.522.00.0060



SFT600 Star Bundt Form

Size: Ø 240 h 100 mm
Volume: 2,3 l
Bulk: 20.600.00.0000
Polybag: 30.600.00.0060



SFT730 Pan Fleur

Size: 300 x 145 h 80 mm
Volume: 2,25 l
Bulk: 20.730.00.0000
Polybag: 30.730.00.0060



SFT802 Little Goose

Size: 130 x 160 h 35 mm
Volume: 300 ml
Bulk: 10.802.00.0000
Polybag: 30.802.00.0060



SFT803 Small Teddy Bear

Size: 125 x 162 h 36 mm
Volume: 300 ml
Bulk: 10.803.00.0000
Polybag: 30.803.00.0060









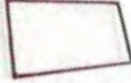

SFT808 Elephant

Size: 135 x 138 h 32 mm
Volume: 260 ml
Bulk: 10.808.00.0000
Polybag: 30.808.00.0060



Safe Ring - Anello sostegno

REF. ITEMS	SIZE	CODE	
SQUARE PAN - SFT 306	305 x 250 h 4 mm	50.306.00.0000 ANSFT 306	
SILICON FLEX SF	173 x 300 h 4 mm	50.000.00.0000 ANSF	
BAKE & ROAST - SFT300	280 x 220 h 4 mm	50.300.00.0000 ANSFT 300	
HAPPY BIRTHDAY	330 x 220 h 4 mm	50.301.00.0000 ANSFT 301	
PLUM CAKE	327 x 120 h 5 mm	50.331.00.0000 ANSFT 331	
PLUM CAKE	240 x 105 h 3 mm	50.326.00.0000 ANSFT 326	
PLUM CAKE	260 x 100 h 3 mm	50.330.00.0000 ANSFT 330	
PLUM CAKE FLOWERS	300 x 145 h 3 mm	50.730.00.0000 ANSFT 730	
ROUND PAN	Ø 180 h 5 mm	50.180.00.0000 ANSFT 180	
ROUND PAN	Ø 200 h 5 mm	50.200.00.0000 ANSFT 200	
ROUND PAN	Ø 240 h 5 mm	50.240.00.0000 ANSFT 240	
ROUND PAN	Ø 260 h 5 mm	50.260.00.0000 ANSFT 260	
ROUND PAN	Ø 280 h 5 mm	50.280.00.0000 ANSFT 280	
STELLA PICCOLA	Ø 260 h 2 mm	50.201.00.0000 ANSFT 201	
TREE	280 x 200 h 5 mm	50.203.00.0000 ANSFT 203	
HEART	220 x 218 h 3 mm	50.210.00.0000 ANSFT 210	
BRIOCHES	Ø 220 h 4 mm	50.522.00.0000 ANSFT 522	

3D DESIGN | CAKE TORTE

3DESIGN

Two dimensions aren't enough anymore! As shapes specialist, Silikomart couldn't resist to develop and explore this concept, unchaining a real pastry revolution!

Le due dimensioni non bastano più! Come specialista delle forme, Silikomart non ha potuto resistere a questo nuovo trend e ha sviluppato questa nuova gamma, scatenando una vera rivoluzione della pasticceria!

- Made in high quality Platinum silicone
 - Food safe silicone
 - Professional results
 - Can be used to -60°C / -76°F
 - Can be used up to +230°C / +446°F
 - Innovative 3D technology
 - Perfect unmoulding
-
- Realizzato in silicone Platinum di alta qualità
 - Adatto all'uso alimentare
 - Risultati da professionista
 - Può essere usato fino a -60°C
 - Può essere usato fino a +230°C
 - Innovativa tecnologia 3D
 - Smodellamento perfetto



3D effect
Effetto 3D

Happy Spring

Size: Ø 200 h 45 mm
Volume: 1250 ml
25.486.13.0065

Set: 1 Silicone mould + 2 Thermoformed Moulds



1 Silicone Mould

+



2 Thermoformed Moulds for Chocolate



THERMOFORMED MOULDS FOR CHOCOLATE

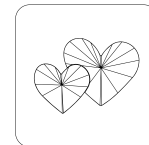

Size: 111 x 80 h 5 mm
Volume: 17.5 ml

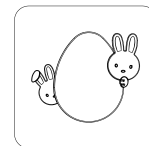

Size: 115 x 96 h 5 mm
Volume: 26 ml

**NON METTERE
IN FORNO**

**DO NOT PUT
IN THE OVEN**



Ninfa

Size: Ø 240 h 54,5 mm
Volume: 1650 ml
20.498.13.0065



Grazia

Size: Ø 220 - Ø 65 h 55 mm
Volume: 1450 ml
20.499.13.0065

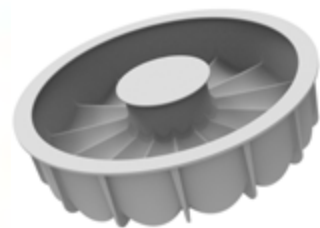



Antea¹¹⁰⁰

Size: Ø 160 h 60 mm
Volume: 1100 ml
30.500.87.0065



Conceived with
Tom Coll

Tom Coll



Neve¹¹⁰⁰

Size: Ø 170 h 53 mm
Volume: 1100 ml
30.464.87.0065



Hiver

Size: Ø 200 h 20 mm
Volume: 1480 ml
20.480.13.0065



Tender

Size: Ø 190 h 65 mm
Volume: 1500 ml
20.481.13.0065



Cocoon

Size: Ø 190 h 61 mm
Volume: 1600 ml
20.485.13.0065



Charme

Size: Ø 193 h 60 mm
Volume: 1600 ml
20.487.13.0065





Maggie

Size: Ø 200 h 52 mm
Volume: 1400 ml
20.468.13.0065



Fairytale

Size: Ø 180 h 65 mm
Volume: 1400 ml
20.474.13.0065



Bunny⁵²⁰

Size: 276 x 268 h 31 mm - Volume: 520 ml
25.341.87.0065

Set: 1 Silicone mould + 1 Plastic base



Silicone Mould



Thermoformed mould for chocolate:
242 x 228 h 6 mm - Vol.: 158 ml

Wave

Size: Ø 195 h 63 mm
Volume: 1400 ml
20.466.13.0065



Love Story

Size: 210 x 173 h 18 mm

Volume: 412 ml

20.454.13.0065

Set: 2 Silicone moulds



2 pcs



Double use cutter

Eclisse

Size: Ø 180 h 45 mm

Volume: 1000 ml

20.455.13.0065



Heartbeat

Size: 250 x 220 h 52 mm
Volume: 1250 ml
20.465.13.0065



Conceived with
Sergey Kulkin



Drees

Size: Ø 185 h 47 mm
Volume: 1200 ml
20.450.13.0065





Endless Love

Size: Ø 190 h 55 mm
Volume: 1500 ml
20.452.13.0065



Nuvola

Size: 220 x 110 h 60 mm
Volume: 800 ml
25.441.13.0065



2 pcs

Mini Dome

Size: Ø 115 h 58 mm
Volume: 409 ml
27.011.87.0065





Passione

Size: Ø 202 h 66 mm
Volume: 1340 ml
20.443.13.0065



Gel 01 XXL

Size: 185 x 95 h 58 mm
Volume: 765 ml
20.439.13.0065

Set: 1 Silicone mould + 1 Thermoformed mould



Thermoformed mould for
chocolate sticks: 88 x 32 h 4 mm



Honoré

Size: Ø 195 h 70 mm
Volume: 1600 ml
20.408.13.0065





Wooly

Size: Ø 190 h 72 mm
Volume: 1460 ml
20.431.13.0065



Color

Size: Ø 200 h 50 mm
Volume: 1460 ml
20.423.13.0065



Moments

Size: Ø 160 h 60 mm
Volume: 1000 ml
72.980.13.0065





Tower

Size: Ø 120 h 100 mm
Volume: 1100 ml
20.421.13.0065



Quadro

Size: 210 x 210 h 35 mm
Volume: 1400 ml
20.417.13.0065



Vinile

Size: Ø 195 h 50 mm
Volume: 1400 ml
20.437.13.0065





Dot

Size: Ø 200 h 60 mm
Volume: 1500 ml
20.379.13.0065



Intreccio

Size: Ø 210 h 70 mm
Volume: 1650 ml
20.384.13.0065



Batticuore

Size: 205 x 198 h 63 mm
Volume: 1500 ml
22.820.13.0065





Raggio

Size: Ø 195 h 68 mm
Volume: 1530 ml
20.362.13.0065



Bolle

Size: Ø 220 h 55 mm
Volume: 1600 ml
20.381.13.0065



Goccia

Size: Ø 220 h 70 mm
Volume: 1650 ml
20.363.13.0065





Gemma

Size: Ø 180 h 90 mm
Volume: 1590 ml
20.374.13.0065



Arena

Size: Ø 220 h 70 mm
Volume: 1700 ml
20.400.13.0065



IO & TE

Size base mould: Ø 210 h 60 mm - Vol.: 1352
Size top mould: Ø 210 h 30 mm - Vol.: 420
25.391.13.0065

Set: 2 Silicone moulds

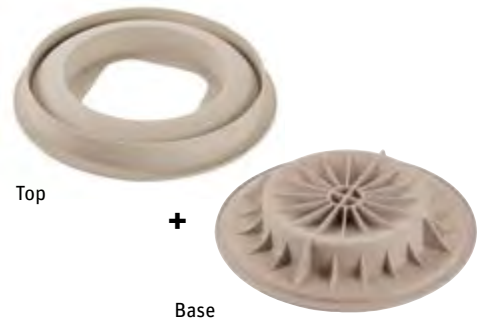

Top

+

Base



Bacio

Size: 250 x 150 h 65 mm
Volume: 1200 ml
20.365.13.0065



Luna

Size: Ø 220 h 60 mm
Volume: 1670 ml
20.361.13.0065



Girotondo

Size: Ø 220 h 57 mm
Volume: 1700 ml
28.340.13.0065





Gioia

Size: Ø 210 h 70 mm
Volume: 1660 ml
20.383.13.0065



Abbraccio

Size: Ø 220 h 65 mm
Volume: 1700 ml
28.337.13.0065



Primavera

Size: Ø 220 h 50 mm
Volume: 1500 ml
28.338.13.0065





Eleganza

Size: Ø 220 h 60 mm
Volume: 1700 ml
28.339.13.0065



Perla 20

Size: Ø 200 h 40 mm
Volume: 1252 ml
27.200.13.0065



Perla 24

Size: Ø 240 h 40 mm
Volume: 1804 ml
27.240.13.0065



3D DESIGN | BÛCHES



Kit North Pole⁹⁴⁰

Size: 210 x 87 h 80 mm

Volume: 940 ml

20.483.87.0065

Set: 2 Silicone moulds + 1 Plastic base

Silicone Moulds

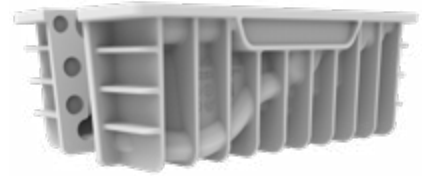

+

Plastic Base

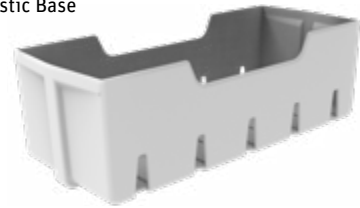

Bûche Signature⁸²⁰

Size: 230 x 80 h 80 mm

Volume: 820 ml

30.475.87.0065





Bûche Snowfall¹¹⁵⁰

Size: 250 x 81 h 58 mm

Volume: 1150 ml

20.482.13.0065



Conceived with
Alistair
Smith

Alistair
Smith

Slope¹⁰⁵⁰

Size: 250 x 80 h 80.5 mm

Volume: 1050 ml

30.492.87.0065



MODULARFLEX TRILOGY
32.148.87.0065 pag. 136



Winter Cottage¹¹⁰⁰

Size: 230 x 105 h 75 mm

Volume: 1100 ml

20.493.87.0065



Nutcracker Bûche¹⁰⁰⁰

Size: 253 x 90 h 75 mm

Volume: 997 ml

20.495.87.0065





Bûche Coeur¹²⁹⁰

Size: 240 x 90 h 90 mm
Volume: 1290 ml
20.467.13.0065



3D effect
Effetto 3D



Bûche Snowy¹⁴⁰⁰

Size: 248 x 88 h 80 mm
Volume: 1400 ml
20.469.13.0065



3D effect
Effetto 3D

Winter Village¹²⁰⁰

Size: 218 x 88 h 80 mm

Volume: 1200 ml

20.438.13.0065

Set: 2 Silicone moulds + 1 Plastic base



Silicone Moulds



+

Plastic Base

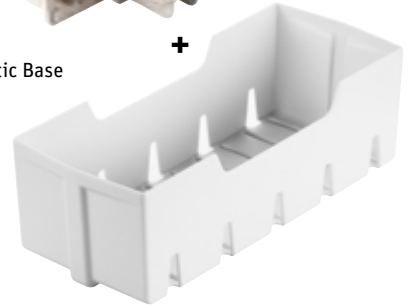

Bûche Lumière¹⁰⁸⁰

Size: 219 x 89 h 75 mm

Volume: 1080 ml

20.451.13.0065

Set: 3 Silicone moulds + 1 Plastic base



Silicone Moulds



+

Plastic Base

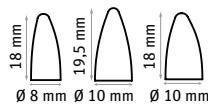
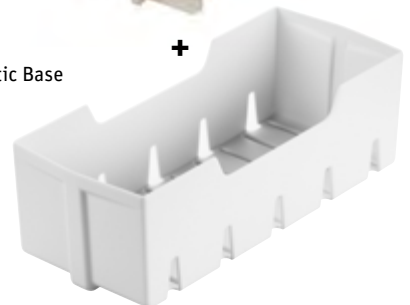

Silicone mould for the flames
Stampo in silicone per fiamme



Kit Woody¹¹⁰⁰

Size: 240 x 100 h 82 mm

Volume: 1100 ml

20.420.87.0065

Set: 2 Silicone moulds + 1 Plastic base

Silicone Moulds



Plastic Base

+

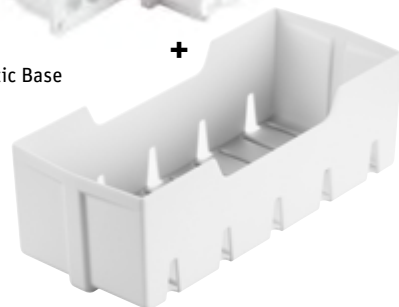

Winter Pine¹²⁰⁰

Size: 250 x 83 h 78 mm

Volume: 1200 ml

30.448.87.0065





Bûche Sapin¹⁰⁰⁰

Size: 250 x 89 h 87 mm

Volume: 1000 ml

20.436.13.0065



3D effect
Effetto 3D

Lana¹²⁰⁰

Size: 245 x 95 h 77 mm

Volume: 1200 ml

20.418.13.0065



3D effect
Effetto 3D



Artic¹⁰⁰⁰

Size: 250 x 92 h 87 mm
Volume: 1000 ml
20.419.13.0065



Meringa¹¹⁰⁰

Size: 250 x 90 h 75 mm
Volume: 1100 ml
20.360.13.0065



3D effect
Effetto 3D



Corallo¹⁴⁰⁰

Size: 245 x 90 h 90 mm
Volume: 1400 ml
20.399.13.0065



3D effect
Effetto 3D



Bûche Quenelle

Size: 243 x 90 h 77 mm
Volume: 1300 ml
20.434.13.0065



3D effect
Effetto 3D



Kit Frutti Rossi

Size: 280 x 120 h 65 mm

Volume: 1510 ml

25.106.13.0065

Set: 2 Silicone moulds

Top



+



3D effect
Effetto 3D

Base



Kit Ice Glow⁹¹⁰

Top Size: 240 x 80 h 60 mm Vol.: 580 ml

Base Size: 260 x 100 h 15 mm Vol.: 330 ml

25.108.99.0065

Set: 2 Silicone moulds

Top



+



3D effect
Effetto 3D

Base





Diamond Bûche¹²⁰⁰

Size: 250 x 90 h 75 mm

Volume: 1200 ml

25.074.63.0065

Set: 1 Plastic Bûche

+2 Silicone mats

+ 2 Silicone headers



2 Silicone headers



Maya Bûche¹²⁰⁰

Size: 250 x 80 h 67 mm

Volume: 1200 ml

25.077.63.0065

Set: 1 Plastic Bûche

+2 Silicone mats

+ 2 Silicone headers



2 Silicone headers



Kit Magic Wood¹³⁰⁰

Size: 296 x 130 h 72 mm

Volume: 1300 ml

25.057.99.0065

Set: 1 Silicone mould + 1 Silicone mat



Magic Bûche¹²⁰⁰

Size: 250 x 80 h 67 mm

Volume: 1200 ml

25.059.63.0065

Set: 1 Plastic Bûche

+2 Silicone mats

+ 2 Silicone headers



2 Silicone headers



Frozen Bûche¹²⁰⁰

Size: 250 x 80 h 67 mm

Volume: 1200 ml

25.071.63.0065

Set: 1 Plastic Bûche

+2 Silicone mats

+ 2 Silicone headers



Starlight Bûche¹²⁰⁰

Size: 250 x 80 h 67 mm

Volume: 1200 ml

25.075.63.0065

Set: 1 Plastic Bûche

+2 Silicone mats

+ 2 Silicone headers



Individual mats also available for Bûche Mould (27.259.87.0060)



Frozen Bûche Mat

Size: 250 x 185 h 6 mm
23.071.63.0065

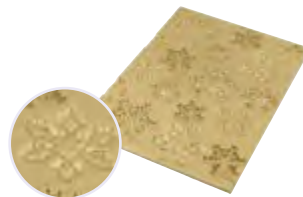

Magic Wood Mat

Size: 250 x 185 h 6 mm
23.057.77.0065



Magic Love Mat

Size: 250 x 185 h 6 mm
23.072.77.0065



Magic Bûche Mat

Size: 250 x 185 h 6 mm
23.059.63.0065

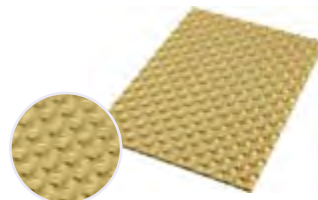

INSERT MOULDS



Insert Project

As the shapes specialist, Silikomart embraced the need to create multiple layers of different tastes and textures in order to create professional-like cakes and entremets.

Silikomart, come specialista delle forme, ha abbracciato la necessità di creare dessert stratificati caratterizzati da gusti e texture diversi per creare torte ed entremets come quelli dei professionisti.



Multi-Inserto Round

Size small insert: Ø 30 h 25 mm
Size savarin insert: Ø 150 h 25 mm
Size big insert: Ø 176 h 25 mm
Volume small insert: 18 ml
Volume savarin insert: 300 ml
Volume big insert: 600 ml
20.405.13.0065



Side A
Lato A



Side B
Lato B



Flip the mould
Capovolgi lo stampo

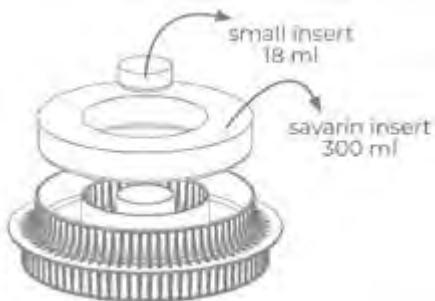

Inserto Bûche & Cake

Small insert: 200 x 35 h 30 mm
Big insert: 220 x 50 h 40 mm
Volume Small insert: 190 ml
Volume big insert: 400 ml
20.404.13.0065



Side A

Side B

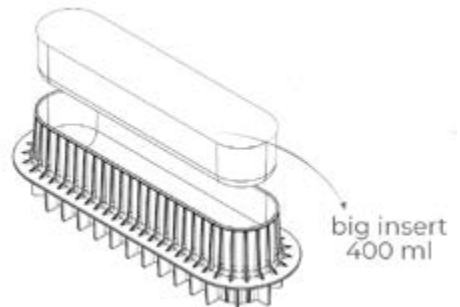
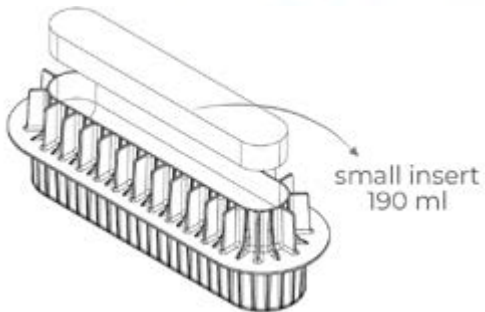

EASY ICE CREAM





Round 3D

Size: Ø 70 h 23 mm
Volume: 82 ml Cavities: 4
25.359.87.0065

Set: 2 Silicone moulds



2 pcs

50 Sticks



Classic 3D

Size: 43 x 93 h 25 mm
Volume: 76 ml Cavities: 4
25.354.87.0065

Set: 2 Silicone moulds

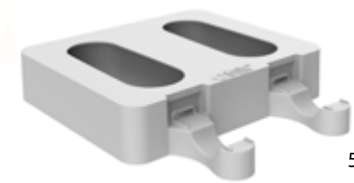

2 pcs

50 Sticks





2 pcs



50 Sticks



SET GEL01 Classic

Size: 93 x 48 h 25 mm
Volume: 180 ml Cavities: 4
25.321.87.0065

Set: 2 Silicone moulds



2 pcs



50 Sticks



SET GEL03 Heart-Ic

Size: 91 x 85 h 23 mm
Volume: 192 ml Cavities: 4
25.323.87.0065

Set: 2 Silicone moulds



2 pcs



50 Sticks



SET GEL02 Chocostick

Size: 92 x 48 h 24 mm
Volume: 180 ml Cavities: 4
25.322.87.0065

Set: 2 Silicone moulds



2 pcs



50 Sticks



SET GEL04 Tango

Size: 92 x 45 h 27,5 mm
Volume: 180 ml Cavities: 4
25.324.87.0065

Set: 2 Silicone moulds

Bastoncini

Size: 113 x 10 h 2 mm
99.400.99.0002

Set: 100 Pcs





GEL01M Mini Classic

Size: 73 x 38 h 18 mm
Volume: 148 ml Cavities: 4
22.341.87.0065

50 Sticks



GEL03M Mini Heart-Ic

Size: 67 x 55 h 18 mm
Volume: 135 ml Cavities: 3
22.343.87.0065

50 Sticks



GEL10M Mini Vintage

Size: 93 x 48 h 180 mm
Volume: 180 ml Cavities: 4
22.350.87.0065

50 Sticks



GEL04M Mini Tango

Size: 67 x 33 h 22 mm
Volume: 144 ml Cavities: 4
22.344.87.0065

50 Sticks



GEL05M Mini Chic

Size: 70 x 33 h 22 mm
Volume: 152 ml Cavities: 4
22.345.87.0065

50 Sticks



Bastoncini Mini

Size: 72 x 8 h 2 mm
99.401.99.0002
Set: 100 Pcs

ICE LOLLY

Size: Ø 41 h 200 mm
Volume: 216 ml
25.430.99.0165

Set: 3 Silicone moulds



SET STICKS EASYPOP

Size: Ø 3,8 h 120 mm
99.411.99.0001

Size: Ø 3,8 h 152 mm
99.412.99.0001

Size: Ø 3,8 h 228 mm
99.413.99.0001



Pop Stand

Size: Ø 220 h 110 mm



White - **25.939.87.0065**



Black - **25.939.20.0065**

Double use:
For Pop sticks & Wood mini sticks

POP03 MAGIC POP

Size: 75,5x72 h12mm
Volume: 136ml
22.703.19.0069



50 Sticks



POP04 DAISY POP

Size: 74Ø h12mm
Volume: 160ml
22.704.19.0069



50 Sticks



POP02 GINGER POP

Size: 75x67 h12mm
Volume: 124ml
22.702.19.0069



50 Sticks



Espogel Up Mini

Size: 235 x 360 h 48 mm

99.432.86.0165

24 pcs Mini Sticks

35 pcs Kono

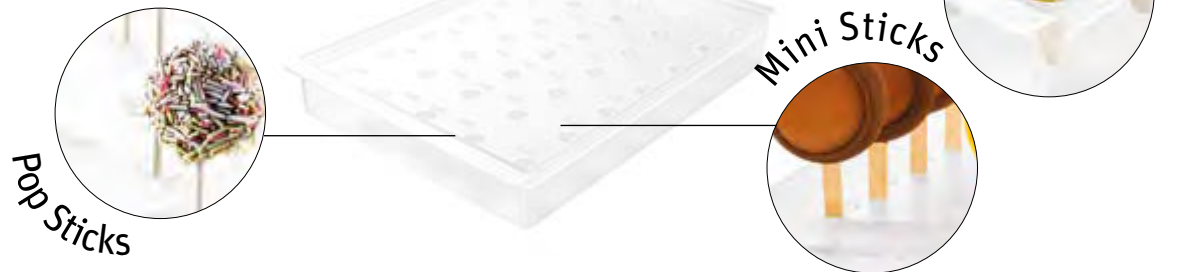

Small total I-Gloo

Tray + Cover iGloo 3.2

Size: 390 x 119 h 32 mm

25.426.87.0098 - White

25.426.20.0098 - Black



Small I-Gloo

Cover iGloo 3.2

Size: 390 x 109 h 32 mm

99.426.86.0000



Vgel03

Tray

Size: 395 x 119 h 12 mm

25.425.87.0098 - White

Set 2 pcs

25.425.20.0098 - Black

Set 2 pcs



3D DESIGN | DECORATIONS DECORAZIONI





Stencil Galette 01

Size: Ø 270 h 2.5 mm

33.210.87.0065

For a 24 cm Galette / *Per una Galette da 24 cm*

Stencil Galette 02

Size: Ø 210 h 2.5 mm

33.212.87.0065

For a 18 cm Galette / *Per una Galette da 18 cm*



Stencil Galette 03

Size: Ø 270 h 2.5 mm

33.213.87.0065

For a 24 cm Galette / *Per una Galette da 24 cm*

Stencil Galette 04

Size: Ø 210 h 2.5 mm

33.214.87.0065

For a 18 cm Galette / *Per una Galette da 18 cm*



Create original gallettes with the Galette Stencils by Silikomart Professional. Place your galette on the stencil and bake it to achieve a unique result.

Create galette originali con gli Stencil Galette di Silikomart Professional. Posizionate la vostra galette sullo stencil e infornatela per ottenere un risultato unico.



Sorriso²

Size: Ø 50 h 1.5 mm
Volume: 2.3 ml Cavities: 7
33.104.87.0065

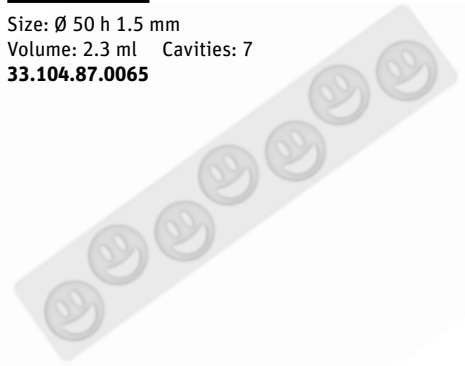

Conceived with
**Pierre et Cristina
Chomet**

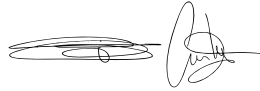

Corolle⁴

Size: Ø 45 h 5.7 mm
Volume: 3.8 ml Cavities: 15
36.442.87.0065

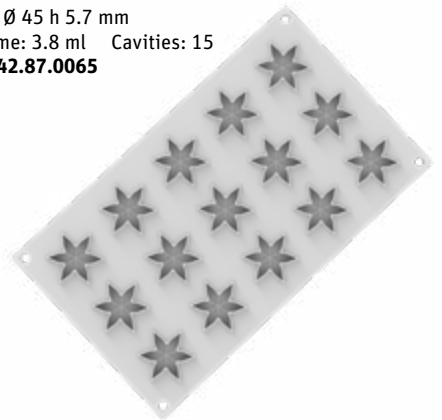

Conceived with
**Florent
Margaillan**





Blossom⁴⁵

Size: Ø 67 h 20 mm

Volume: 45 ml Cavities: 8

36.396.87.0065



Crown Honoré²⁷⁰

Size: Ø 177 h 18 mm - Ø 69 h 14 mm

Volume: 240 - 33 ml

30.444.87.0065





Bloom⁴⁵

Size: Ø 76.5 h 17 mm
Volume: 45 ml Cavities: 6
36.413.87.0065



Bloom³⁰⁰

Size: Ø 173 h 22 mm
Volume: 300 ml
30.471.87.0065





Bliss

Size: Ø 140 h 10 mm
Volume: 100 ml Cavities: 2
36.396.87.0065



Flower Power

Size: Size: Ø 140 h 10 mm
Volume: 80 ml Cavities: 2
26.391.13.0065





Flora⁷

Size: Ø 45 h 7 mm
 Volume: 7 ml Cavities: 15
36.393.87.0065

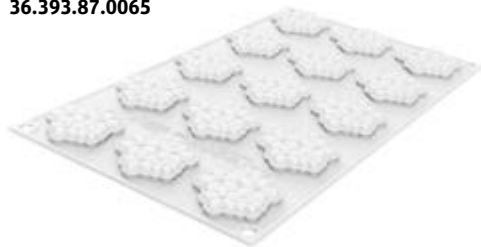

Flora¹⁹

Size: Ø 75 h 8 mm
 Volume: 19 ml Cavities: 6
36.392.87.0065



Flora⁸⁰

Size: Ø 140 h 10 mm
 Volume: 80 ml Cavities: 2
36.391.87.0065





Saint Honoré⁴⁰

Size: Ø 76 h 15 mm
Volume: 40 ml Cavities: 8
36.365.87.0065



Saint Honoré²⁸⁰

Size: Ø 160 h 28 mm
Volume: 280 ml
30.445.87.0065





Tutù⁷

Size: Ø 45 h 6 mm
 Volume: 7 ml Cavities: 15
36.384.87.0065



Tutù²⁴

Size: Ø 75 h 8 mm
 Volume: 24 ml Cavities: 6
36.383.87.0065



Tutù¹⁰⁰

Size: Ø 140 h 9 mm
 Volume: 100 ml Cavities: 2
36.382.87.0065

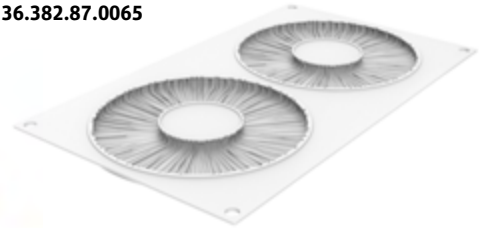



Plissé⁷

Size: Ø 45 h 6.4 mm
 Volume: 7 ml
 Cavities: 15
36.313.87.0065



Plissé²³

Size: Ø 75 h 7.7 mm
 Volume: 23 ml
 Cavities: 6
36.312.87.0065



Plissé¹⁰⁰

Size: Ø 140 h 10 mm
 Volume: 100 ml
 Cavities: 2
36.311.87.0065





Miel⁸

Size: Ø 45 h 8 mm
 Volume: 8 ml
 Cavities: 15
36.347.87.0065

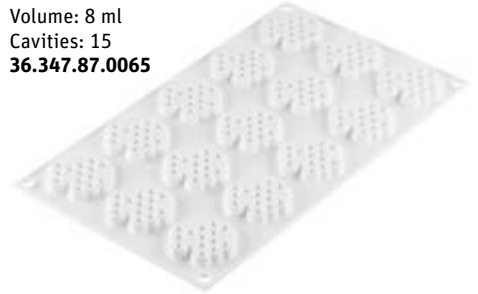

Miel¹⁸

Size: Ø 74 h 8 mm
 Volume: 18 ml
 Cavities: 6
36.346.87.0065



Miel⁸⁰

Size: Ø 140 h 10 mm
 Volume: 80 ml
 Cavities: 2
36.345.87.0065





Alvéolé³

Size: Ø 75 h 2,5 mm Cavities: 5
33.099.87.0065



Alvéolé⁹

Size: Ø 140-180 h 2,5 mm Cavities: 2
33.100.87.0065

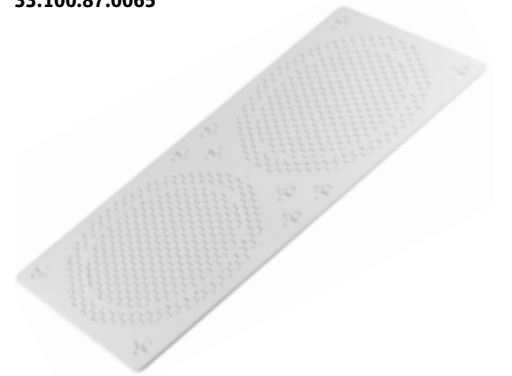



Cocoa³⁵

Size: Ø 60 h 20 mm
Volume: 35 ml
Cavities: 8
36.309.87.0065



Paradis³⁷

Size: Ø 70 h 11 mm
Volume: 37 ml
Cavities: 6
36.298.87.0065



Honoré³⁵

Size: Ø 70 h 13 mm
Volume: 35 ml
Cavities: 8
36.294.87.0065





Tourbillon⁹

Size: Ø 45 h 7 mm
 Volume: 9 ml
 Cavities: 15
36.229.87.0065



Tourbillon²⁸

Size: Ø 75 h 8 mm
 Volume: 28 ml
 Cavities: 6
36.230.87.0065



Tourbillon¹⁰⁰

Size: Ø 140 h 9 mm
 Volume: 100 ml
 Cavities: 2
36.231.87.0065





Adore

Size: 69 x 61 h 2 mm
Cavities: 6
23.103.13.0065



Grace

Size: 57 x 59 h 1 mm
69 x 45 h 1 mm
Cavities: 6
23.102.13.0065





Chablon Bûche

Size: 96 x 73 - 81 x 69 - 96 x 73 h 2 mm
 Volume: 2 x 10 ml + 2 x 12 ml + 2 x 14 ml
 Cavities: 8
27.006.13.0065

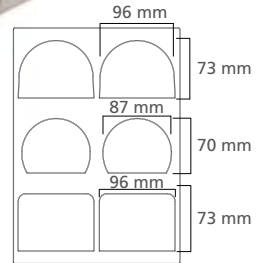

Snowball

Size: Ø 60 h 1.5 mm
 Cavities: 6
23.101.13.0065



Garden

Size: 37 x 60 - 30 x 65 - 43 x 63 h 1.5 mm
 Cavities: 9
23.089.13.0065





Decor Round⁵⁰

Size: Ø 67 h 15 mm
Volume 50 ml
Cavities: 6
36.243.87.0065



Decor Round⁸⁰

Size: Ø 85 h 15 mm
Volume 80 ml
Cavities: 4
36.277.87.0065



Decor Round¹⁴⁰

Size: Ø 105 h 17 mm
Volume 140 ml
Cavities: 2
36.285.87.0065



Decor Round²³⁰

Size: Ø 122 h 20 mm
Volume 230 ml
Cavities: 2
36.244.87.0065





Decor Round⁴⁰⁰

Size: Ø 160 h 20 mm
Volume: 400 ml
30.369.87.0065



Decor Round⁴⁶⁰

Size: Ø 175 h 20 mm
Volume: 460 ml
30.385.87.0065



Decor Square⁶⁰

Size: 67 x 67 h 15 mm
Volume: 60 ml
Cavities: 6
36.286.87.0065



Decor Square⁵⁶⁰

Size: 170 x 170 h 20 mm
Volume: 560 ml
30.388.87.0065



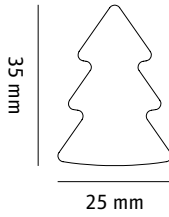

Chablon Tree

Size: 35 x 25 h 2 mm
Volume: 1 ml Cavities: 36
25.009.86.0065

Set: 2 pcs

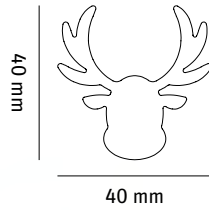

Chablon Rudolph

Size: 40 x 40 h 2 mm
Volume: 1,2 ml Cavities: 24
25.010.86.0065

Set: 2 pcs



21 mm

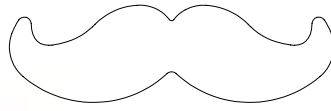

70 mm

11 mm



38 mm



Chablon Mustache

Size: 11 x 38 h 2 mm - Vol.: 0,7 ml - Cavities: 33
Size: 21 x 70 h 2 mm - Vol.: 2 ml - Cavities: 10
25.007.86.0065

Set: 2 pcs



31 mm

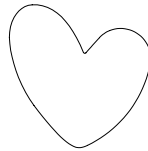

31 mm



Chablon Heart 31x31 mm

Size: 31 x 31 h 2 mm
Volume: 0,5 ml Cavities: 30
25.008.86.0065

Set: 2 pcs



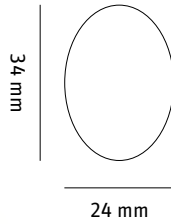

Chablon Oval

Size: 34 x 24 h 2 mm
Volume: 1,2 ml Cavities: 45
25.002.86.0065

Set: 2 pcs

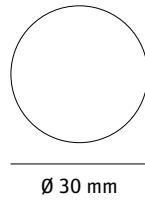

Chablon Round

Size: Ø 30 h 2 mm
Volume: 1,4 ml Cavities: 42
25.001.86.0065

Set: 2 pcs



Decors

How to use - *Modo d'uso*



· To impress the decoration directly onto the preparation, place the mould with the decorated side up in a Tor180 / Multiflex170.

To instead create a decoration to be placed on the finished product, fill the mould with chocolate or tuile with the help of a spatula.

· Per imprimere il decoro direttamente sulla preparazione, posizionare in una Tor180 / Multiflex170 lo stampo con il lato decorato verso l'alto. Per creare invece un decoro da appoggiare sul prodotto finito, spatolare lo stampo con cioccolato o tuile.



· Unmould the mixture from the Tor180 / Multiflex170 mould and gently remove the decorative mould.

· Sformare il composto dallo stampo Tor180 / Multiflex170 e rimuovere delicatamente lo stampo decorativo.

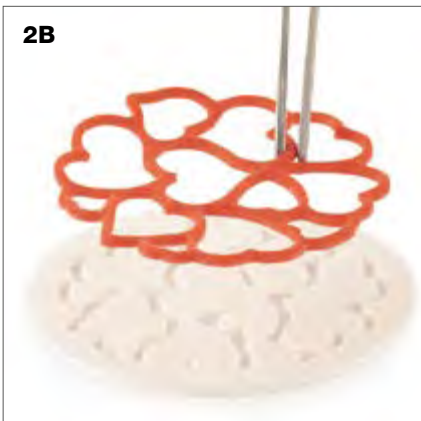

· Remove the decoration from the mould and place it on top of the finished product.

· Estrarre il decoro dallo stampo e appoggiarlo sopra al prodotto finito.

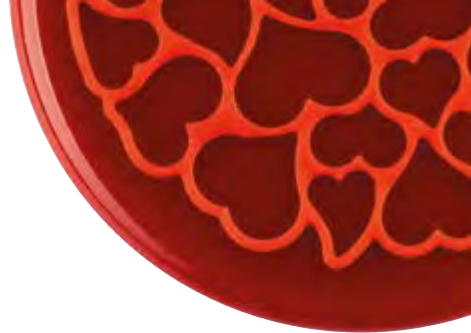



Stars decor

Size: Ø 180 - 145 h 2.5 mm
Volume: 20 ml
33.133.87.0065



Mini stars decor

Size: Ø 70 - 60 h 2.5 mm
Volume: 4 ml
Item: 25.134.87.0065
Set: 6 pcs



Dad decor

Size: Ø 180 - 145 h 2.5 mm

Volume: 22 ml

33.132.87.0065

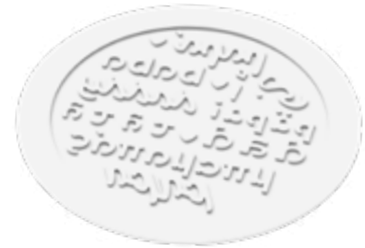

Mum decor

Size: Ø 180 - 145 h 2.5 mm

Volume: 22 ml

33.131.87.0065





Birthday decor

Size: Ø 180 h 2.5 mm

Volume: 8 ml

33.135.87.0065



Mini tiramisù decor

Size: Ø 70 - 60 h 2.5 mm

Volume: 4 ml

25.136.87.0065

Set: 6 pcs





Tiramisu decor

Size: Ø 180 - 145 h 2,50 mm
Volume: 28 ml
33.126.87.0065



Cheesecake decor

Size: Ø 180 - 145 h 2,50 mm
Volume: 25 ml
33.127.87.0065





Coffee decor

Size: Ø 180 - 145 h 2,5 mm
Volume: 14,5 ml
33.128.87.0065



Mini coffee decor

Size: Ø 70 - 60 h 2,5 mm
Volume: 3,6 ml
25.129.87.0065
Set: 6 pcs



Love Decor

Mould size: Ø 180 - 145 h 2,5 mm

Volume: 9 ml

33.124.87.0065

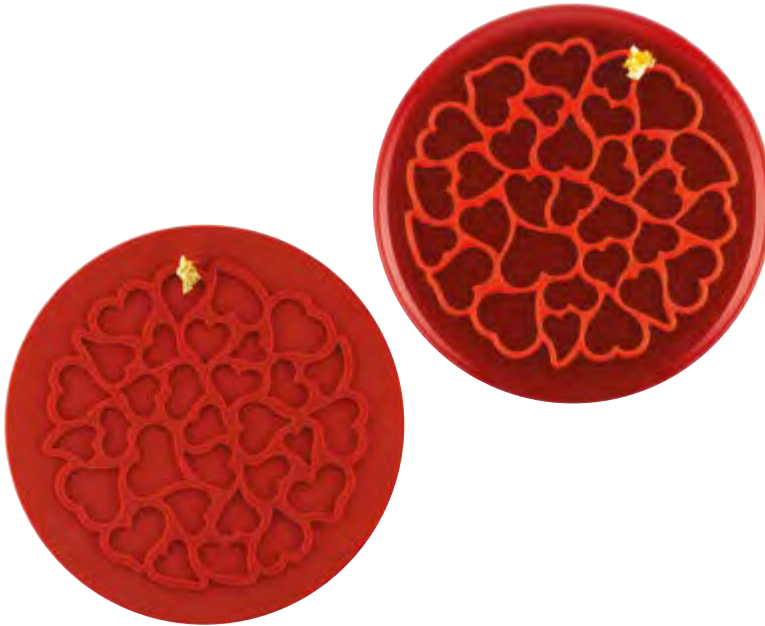

Mini Love Decor

Size: Ø 70 - 60 h 2,8 mm

Volume: 2 ml

25.125.87.0065

Set: 6 pcs

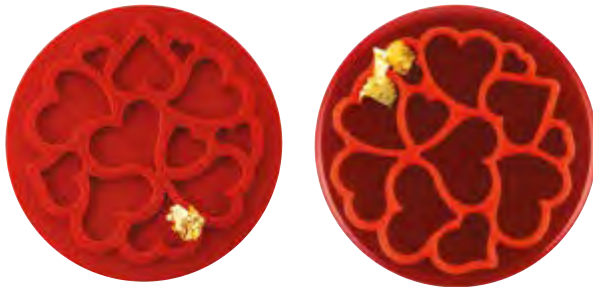

DECORS DISPLAY B2B

Display Size:
255 x 350 h 240 mm
25.124.87.0065

Kit containing
24 assorted decorations
*Kit comprensivo
di 24 Decors misti*

Display A:

- 6 TIRAMISU DECOR
- 6 CHEESECAKE DECOR



+



Display B:

- 3 COFFEE DECOR
- 3 MINI COFFEE DECOR
- 3 LOVE DECOR
- 3 MINI LOVE DECOR

Ghirlanda Decor

Size: Ø 180 - 145 h 2,5 mm

Volume: 10 ml

33.130.87.0065



Déco

Size: 557 x 50 h 7 mm
33.161.87.0065



Osier

Size: 554 x 50 h 4.7 mm
33.162.87.0065



Graduated stripe to create decorations with a diameter between \varnothing 115mm and \varnothing 180 mm.
Fascia graduata per realizzare decorazioni con un diametro compreso tra \varnothing 115 mm e \varnothing 180 mm.

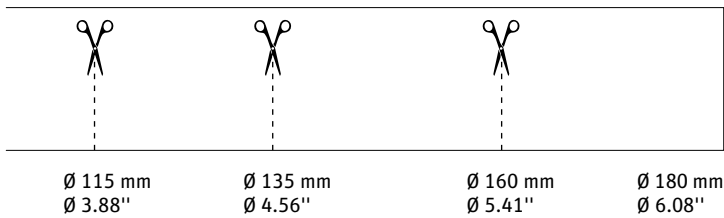

Also for steel rings
Anche per anelli in acciaio





Goccia

Size: Ø 60 - 260 h 45 mm
25.101.99.0065

Set: 1 Silicone stripe + 1 PVC roll + 1 Spatula



Silicone stripe

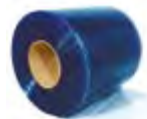

PVC roll

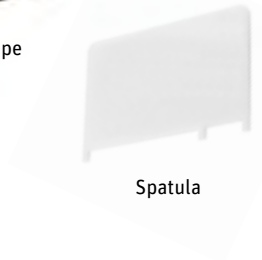

Spatula



Fuoco

Size: Ø 60 - 260 h 45 mm
25.102.99.0065

Set: 1 Silicone stripe + 1 PVC roll + 1 Spatula



Silicone stripe



PVC roll

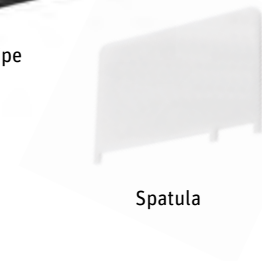

Spatula

Silfry

SILICONE MOULDS FOR AIR FRYER

STAMPI IN SILICONE

PER FRIGGITRICE AD ARIA



Silfry

I'm Italian, safe to use, I cook amazingly well and, I swear, I keep everything clean!

Sono italiano, sono sicuro, cucino benissimo e, te lo giuro, non sporco!

SILICONE MOULDS FOR AIR FRYER *STAMPI IN SILICONE PER FRIGGITRICE AD ARIA*

Made from 100% food-grade silicone and BPA/PFAS free, Silfry is the range designed for those looking for convenience, safety and sustainability in the kitchen. Each item is resistant to high temperatures (+230°C/446°F), flexible and non-stick, ideal for stress-free everyday use. Easy to clean and reusable, Silfry products reduce washing time and the use of parchment paper or disposable accessories. Space-saving, versatile and compatible with most air fryers, they make cooking even easier, faster and tastier.

Realizzata in 100% silicone alimentare e BPA/PFAS free, Silfry è la linea pensata per chi cerca praticità, sicurezza e sostenibilità in cucina. Ogni articolo è resistente alle alte temperature (+230°C), flessibile e antiaderente, ideale per un utilizzo quotidiano senza stress. Facilissimi da pulire e riutilizzare, i prodotti Silfry riducono i tempi di lavaggio e l'uso di carta forno o accessori usa e getta. Salvaspazio, versatili e compatibili con le principali friggitrici ad aria, rendono la cottura ancora più semplice, veloce e gustosa.

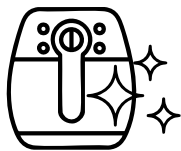

Keeps the air fryer clean
Mantiene pulita la friggitrice ad aria

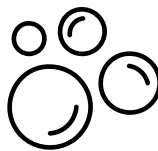

Dishwasher safe
Lavabile in lavastoviglie

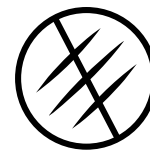

Protects the basket
Protegge il cestello

Each mold comes with fabulous recipes.
Ogni stampo è accompagnato da favolose ricette.



Silfry Mat 195x170 mm

Size: 195 x 170 h 7 mm
70.192.55.0065



Silfry Mat 215x215 mm

Size: 215 x 215 h 7 mm
70.191.55.0065



Silfry Egg

Size Cavity: Ø 58 h 34 mm
Size Mould: 215 x 215 h 36 mm
Volume: 9 x 70 ml
70.193.55.0065



Silfry Muffin

Size Cavity: Ø 45/72 h 34 mm

Volume: 6 x 80 ml

25.420.55.0065



x 6 Pcs



Silfry Bread

Size: 150 x 100 h 75 mm

21.004.55.0062



Silfry Cake

Size: Ø 180 h 65 mm

Volume: 1500 ml

20.180.55.0062



Silfry Bowl

Size: Ø 185 h 65 mm

Volume: 1200 ml

24.003.55.0065



SNACKS & CO.



BURGER BREAD

Size: Ø 80 h 20 mm
21.001.13.0065



Perforated pattern
Texture forata



MINI BAGUETTE BREAD

Size: 170 x 55 h 20 mm
21.002.13.0065

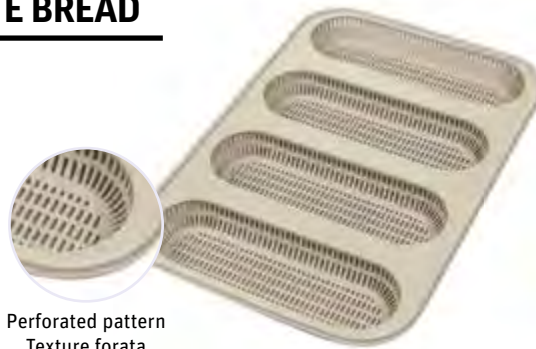

Perforated pattern
Texture forata



FOCACCIA BREAD

Size: 375 x 295 h 30 mm
21.003.13.0065



Perforated pattern
Texture forata



SANDWICH BREAD

Size: 150 x 100 h 75 mm
21.004.13.0065

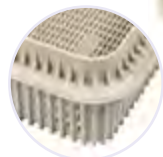

Perforated pattern
Texture forata



TRECCIA

Size: 288 x 156 h 83 mm
Volume: 2100 ml
20.340.13.0065



BAKE'N ROLL

Size: 110 x 97 h 78 mm
72.411.76.0065



SNACK'N ROLL

Size: 110 x 97 h 78 mm
72.412.85.0065



SURPRISE

Size: 75 x 50 mm
72.401.61.0065

- + 80 Foglietti
- + 80 Sheets
- + 80 Papiers



FOR YOU

Size: 76 x 72 mm
72.402.61.0065

- + 80 Foglietti
- + 80 Sheets
- + 80 Papiers



AIRPLUS | MICRO-PERFORATED MOULDS STAMPI MICROFORATI



AIRPLUS®

A REVOLUTIONARY BAKING · UNA COTTURA RIVOLUZIONARIA

NEW MICRO-PERFORATED MOLDS

New micro-perforated silicone molds with a glass fiber ideal for baking. These innovative molds thanks to their micro-perforated texture allow a uniform diffusion of the reducing cooking times and ensuring a perfect result. Perfect both for sweet and savory creations. They are ideal for create tarts, leavened products, short pastry and crust. The moulds are non-stick and can be used on both sides to prepare empty or stuffed tartlets. Temperature range: -40°F +446°F.

NUOVI STAMPI MICROFORATI

Nuovi stampi microforati in fibra di vetro ideali per la cottura. Questi innovativi stampi grazie alla loro trama microforata consentono una diffusione uniforme del calore, riducendo i tempi di cottura e garantendo un risultato perfetto. Ideali sia per creazioni dolci che salate. Sono ideali per creare crostate, prodotti lievitati e sfoglie. Gli stampi sono antiaderenti e possono essere utilizzati su entrambi i lati per preparare tartellette vuote o ripiene. Range di temperatura: - 40 ° C + 230 ° C.



Ideal for all kind of batters, pastries and doughs: perfect for sponge cakes, shortcrust, flaky textures, puff pastry and yeasted dough.

Ideali per tutti i tipi di impasto, texture e consistenze: dalle masse montate ai lievitati sfogliati, alle paste friabili.



The dough remains inside the micro-perforated mould cavity and does not leak out.

L'impasto rimane contenuto nella cavità dello stampo microforato e non fuoriesce.



Non stick mould.

Stampo antiaderente.



Easy and perfect unrolling.

Smodellamento semplice e perfetto.



The mould can be used on both sides to prepare shortcrust pastry or brisée pastry shells and stuffed tartlets.

Stampo utilizzabile su entrambi i lati per preparare gusci di pasta frolla o pasta brisée e tartellette ripiene.



Airplus 02 Plum Cake

Size: 270 x 70 h 30 mm Cavities: 2

Nylon: 70.502.20.0498

Set: 4 moulds

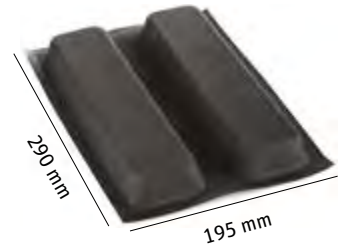
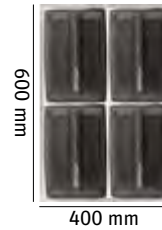

Airplus 03 Mini Plumcake

Size: 95 x 40 h 25 mm Cavities: 6

Nylon: 70.503.20.0498

Set: 4 moulds

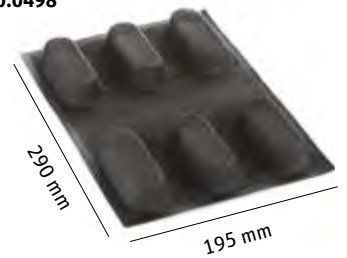
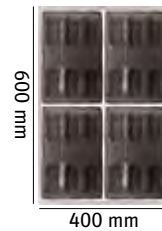

Airplus 11 Eclair

Size: 125 x 25 h 5 mm Cavities: 16

Nylon: 70.511.20.0298 - Gift Box: 70.511.20.0065

Set: 2 moulds

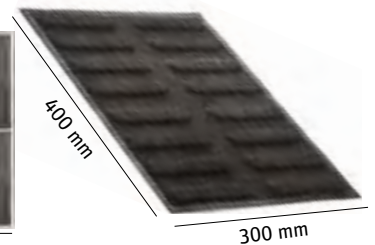

Airplus 12 Round

Size: Ø 120 h 30 mm Cavities: 4

Nylon: 70.512.20.0298 - Gift Box: 70.512.20.0065

Set: 2 moulds

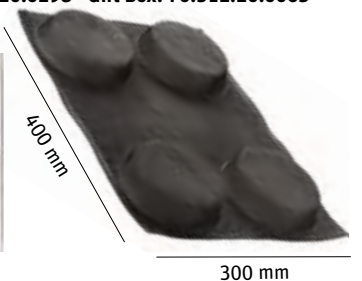
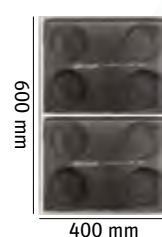



Airplus 13 Round

Size: Ø 60 h 40 mm Cavities: 12

Nylon: 70.513.20.0298 - Gift Box: 70.513.20.0065

Set: 2 moulds

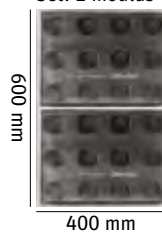

300 mm



Airplus 14 Round

Size: Ø 85 h 20 mm Cavities: 6

Nylon: 70.514.20.0298 - Gift Box: 70.514.20.0065

Set: 2 moulds

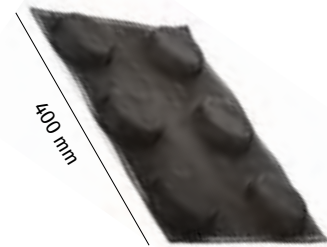
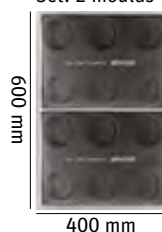

300 mm



Airplus 15 Round

Size: Ø 40 h 16 mm Cavities: 24

Nylon: 70.515.20.0298 - Gift Box: 70.515.20.0065

Set: 2 moulds

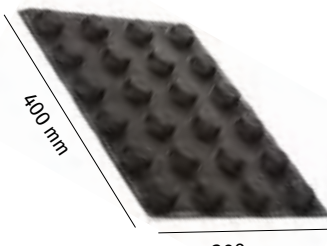
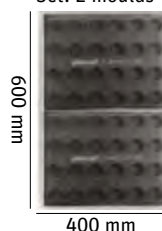

300 mm



Airplus 16 Round

Size: Ø 50 h 16 mm Cavities: 20

Nylon: 70.516.20.0298 - Gift Box: 70.516.20.0065

Set: 2 moulds

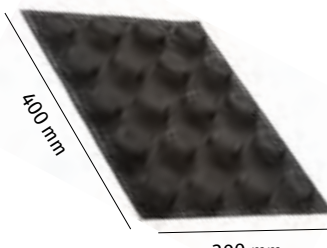
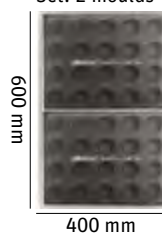

300 mm



Airplus 17 Square

Size: 50 x 50 h 20 mm Cavities: 20

Nylon: 70.517.20.0298 - Gift Box: 70.517.20.0065

Set: 2 moulds

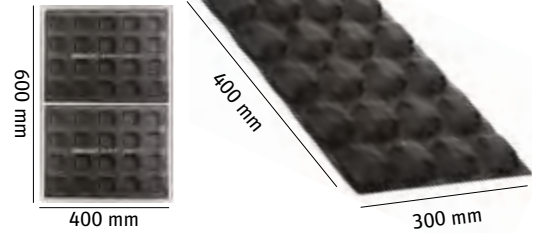

Airplus 18 Round

Size: Ø 48 h 22 mm Cavities: 20

Nylon: 70.518.20.0298 - Gift Box: 70.518.20.0065

Set: 2 moulds

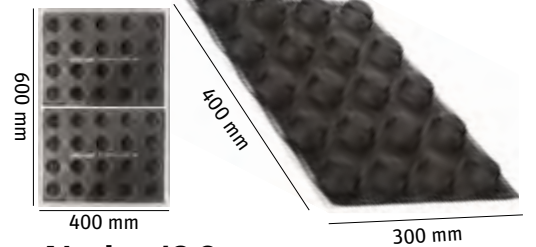

Airplus 19 Square

Size: 85 x 85 h 20 mm Cavities: 6

Nylon: 70.519.20.0298 - Gift Box: 70.519.20.0065

Set: 2 moulds

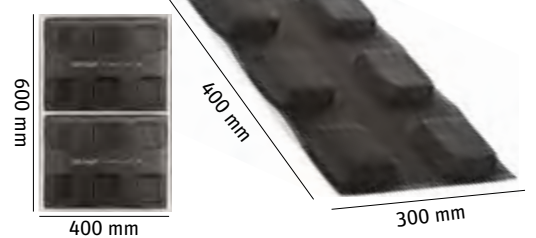

Airplus 20 Square

Size: 35 x 35 h 16 mm Cavities: 30

Nylon: 70.520.20.0298 - Gift Box: 70.520.20.0065

Set: 2 moulds

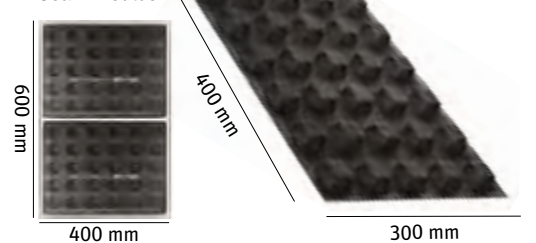



Airplus 21 Triangle

Size: 60 x 60 x 60 h 25 mm Cavities: 15
Nylon: 70.521.20.0298 - Gift Box: 70.521.20.0065

Set: 2 moulds

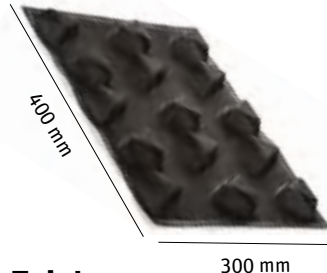
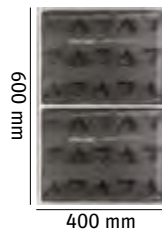

Airplus 31 Eclair

Size: 125 x 25 h 5 mm Cavities: 32
Nylon: 70.531.20.0098 - Gift Box: 70.531.20.0065

Set: 1 moulds

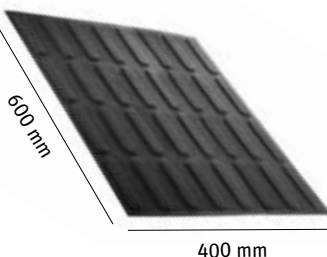
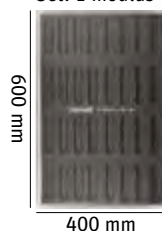

Airplus 32 Midi Plumcake

Size: 130 x 48 h 20 mm Cavities: 24
Nylon: 70.532.20.0098 - Gift Box: 70.532.20.0065

Set: 1 moulds

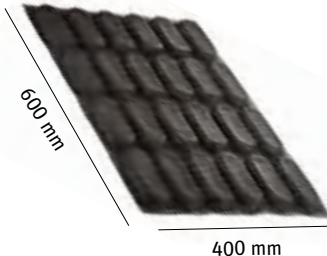
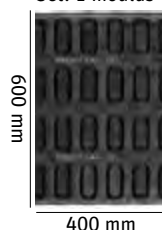

Airplus 33 Round

Size: Ø 104 h 20 mm Cavities: 15
Nylon: 70.533.20.0098

Set: 1 moulds

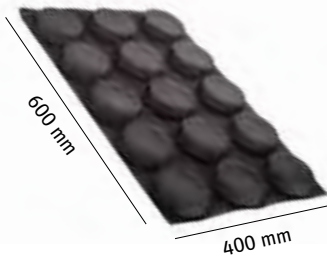
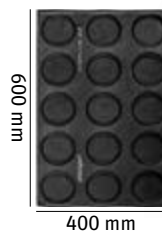



Airplus 34 Round

Size: \varnothing 125 h 18 mm Cavities: 11

70.534.20.0098

Set: 1 moulds

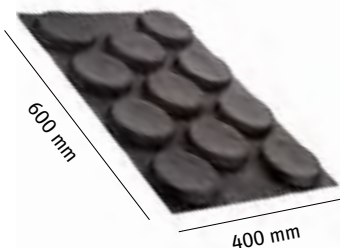
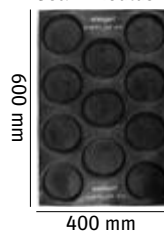

Airplus 35 Round

Size: \varnothing 147 h 12 mm Cavities: 6

70.535.20.0098

Set: 1 moulds

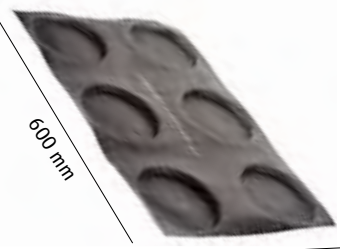
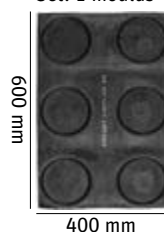

Airplus 36 Round

Size: \varnothing 36 h 10 mm Cavities: 70

70.536.20.0098

Set: 1 moulds

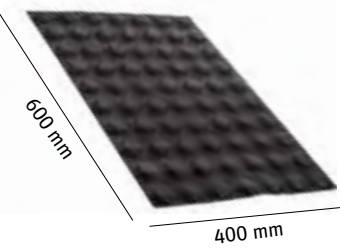
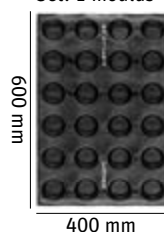

Airplus 37 Round

Size: \varnothing 110 h 20 mm Cavities: 12

70.537.20.0098

Set: 2 moulds

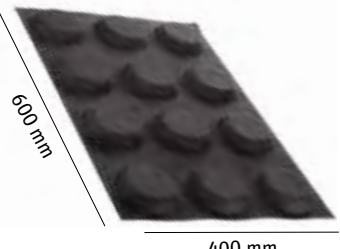
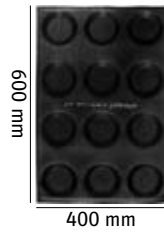



Airplus 38 Round

Size: \varnothing 70 h 30 mm Cavities: 24
70.538.20.0098

Set: 1 moulds

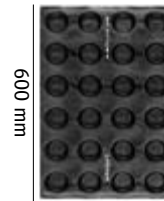

600 mm

400 mm

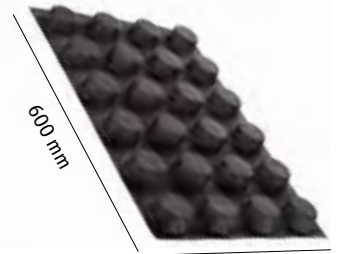

600 mm

400 mm



Airplus 39 Midi Plumcake

Size: 155 x 41 h 25 mm Cavities: 18
70.539.20.0098

Set: 1 moulds

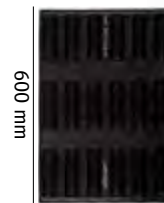

600 mm

400 mm

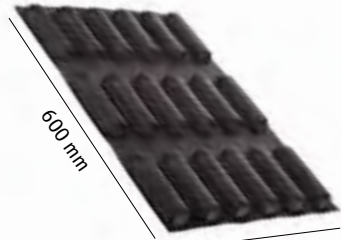

600 mm

400 mm



Airplus 40 Plumcake

Size: 370 x 70 h 30 mm Cavities: 6
70.540.20.0098

Set: 1 moulds

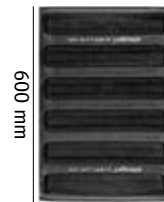

600 mm

400 mm

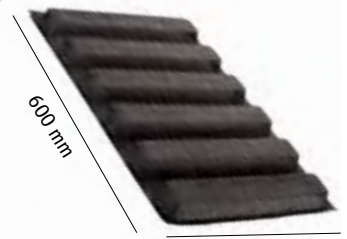

600 mm

400 mm



Airplus 41 Plumcake

Size: 120 x 50 h 20 mm Cavities: 20
70.541.20.0098

Set: 1 moulds

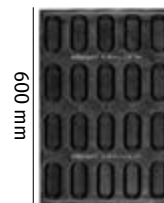

600 mm

400 mm

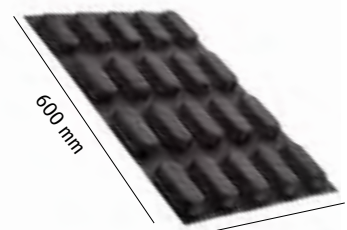

600 mm

400 mm

AIRPLUS® STRIPS

Practical and functional micro-perforated strips ideal for baking shortcrust pastry for tarts and leavened pastry. Airplus Strips take advantage of the technology of the fiberglass texture, which makes the strips completely non-stick. The micro-holes allow a uniform diffusion of the heat for a perfect baking and an quick unmoulding without the necessity of greasing them. Airplus Strips are ideal for an easy stocking in the lab. The strips are washable and reusable. 5 pcs set.
Temperature range: - 40°C + 230°C (-40°F +446°F) .

Pratiche e funzionali fasce microforate ideali per la cottura della pasta frolla e dei lievitati. Le Airplus Strips sfruttano la tecnologia e l'antiaderenza della fibra di vetro intrecciata, che rende le fasce perfettamente antiaderenti. I microfori consentono una diffusione uniforme del calore per una cottura perfetta e una sfornatura veloce senza la necessità di ungerle. Le Airplus Strips sono l'ideale per una facile gestione di stoccaggio in laboratorio, le fasce sono facilmente lavabili e riutilizzabili. Set da 5 strips.
Range di temperatura: - 40°C +230°C



Airplus Strip Ø 140-160

Size: da Ø 140 a Ø 160 h 40 mm

70.550.20.0065

Set: 5 strips



Airplus Strip Ø 160-180

Size: da Ø 160 a Ø 180 h 40 mm

70.551.20.0065

Set: 5 strips



Airplus Strip Ø 180-200

Size: da Ø 180 a Ø 200 h 40 mm

70.552.20.0065

Set: 5 strips



TARTE DECOR



TarteDecor

The new TARTE DECOR project renews the concept of tarts through innovative materials and designs, the right mix of innovation and tradition to easily obtain a perfect tart worthy of a pastry chef.

Il nuovo progetto TARTE DECOR rinnova il concetto di crostate attraverso materiali e design innovativi, il giusto mix di innovazione e tradizione per ottenere facilmente una crostata perfetta come quella di un pasticcere.

ANELLO IN TPLUS - TPLUS RING

- Easy and perfect unmoulding
- Homogeneous baking
- Undeformable
- Stainless
- Non-stick
- Facile da smodellare
- Cottura omogenea indeformabile
- Antiaderente
- Non deve essere imburato
- It should not be greased
- Dishwasher safe
- High thermal stability
- Can be used as a cutter
- Lavabile in lavastoviglie
- Elevata stabilità termica
- Si può usare come coppapasta



How to use: *Modo d'uso:*



Kit Tarte Ring Albia Ø 70 mm

Ring size: Ø 70 h 20 mm

Mould size: Ø 65 h 61 mm Vol.: 106 ml Cavities: 6
25.443.87.0065



Conceived with
Angelo Musa

Kit 3D Tarte Ring Tornado Ø 80 mm

3D Ring size: Ø 80 h 20 mm

Mould size: Ø 77 h 16 mm Vol.: 61ml Cavities: 6
25.438.87.0065



Conceived with
David
Vidal



Conceived with
**Carminé
 Di Donna**

Kit 3D Tarte Ring Cabossa

120x40 mm

3D ring size: 120 x 40 h 20 mm

Mould size: 120 x 40 h 20 mm

Volume: 39 ml Cavities: 6

25.470.87.0065

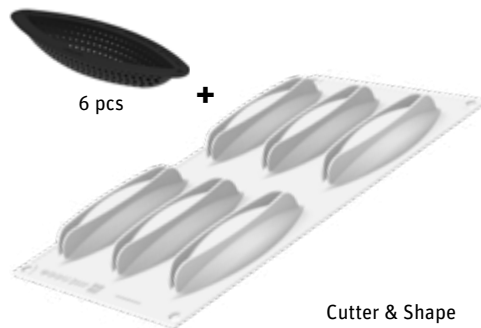

6 pcs

+

Cutter & Shape



Conceived with
**Carminé
 Di Donna**

3D Tarte Ring Oval

120x40 h 20 mm

3D ring size: 120 x 40 h 20 mm

52.470.20.0165



6 pcs

+

Cutter & Shape





Tarte Ring Classic

Ring size: Ø 160 h 35 mm
52.368.20.1065

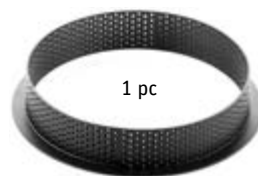

Kit Tarte Ring Amore 80x70 mm

Size ring: 80 x 70 h 20 mm
Silicone mould Vol.: 31 ml Cavities: 8
25.317.87.0065

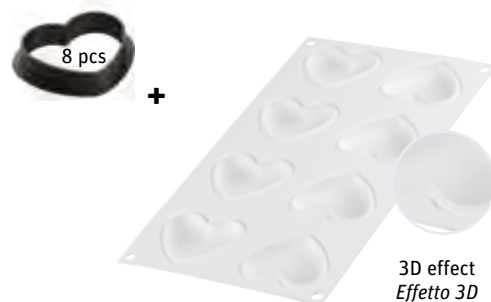

Kit Tarte Ring Amore 205x190 mm

Size ring: 205 x 190 h 20 mm
Silicone mould Vol.: 460 ml Cavities: 1
20.407.87.0065

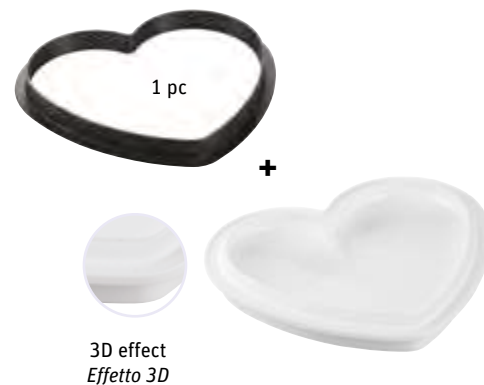



Kit Tarte Grafique Ø 250 mm

Ring size: Ø 250 h 20 mm
Mould size: Ø 230 h 20 mm Vol.: 710 ml
23.202.13.0065

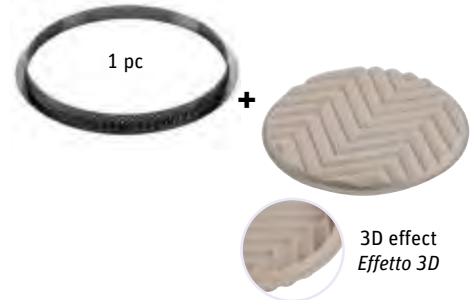

Kit Tarte Meringué Ø 250 mm

Ring size: Ø 250 h 20 mm
Mould size: Ø 230 h 18 mm Vol.: 480 ml
23.201.13.0065

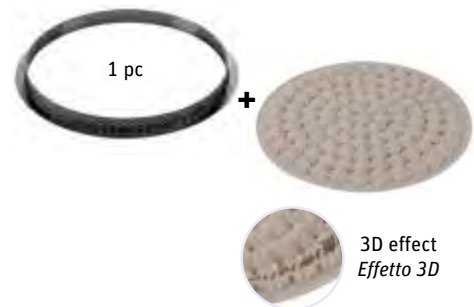

Kit Tarte Liberty 200x200 mm

Ring size: 200 x 200 h 20 mm
Mould size: 180 x 180 h 20 mm - Vol.: 560 ml
20.398.13.0065

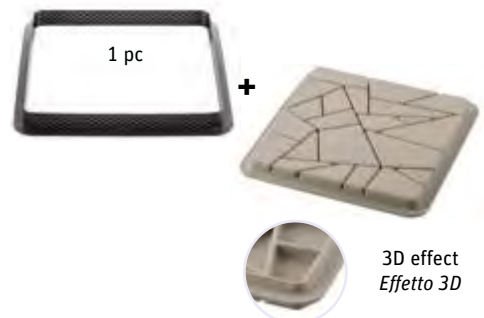



Kit Tarte Bamboo

265x105 mm

Ring size: 265 x 105 h 20 mm

Mould size: 250 x 90 h 20 mm Vol.: 380ml

23.109.13.0065

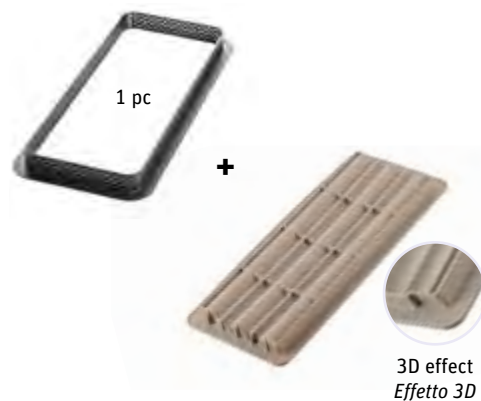

Kit Tarte Nouvelle Vague

265x105 mm

Ring size: 265 x 105 h 20 mm

Mould size: 240 x 80 h 24 mm Vol.: 290 ml

23.107.13.0065

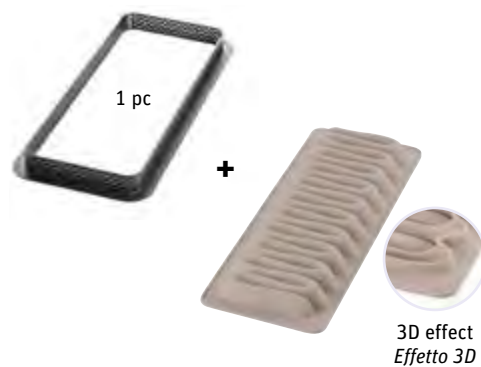



Kit Mini Tarte Twist

Ring size: Ø 80 h 20 mm
 Mould size: Ø 70 h 25 mm Vol.: 53ml Cavities: 6
 25.273.13.0065



Kit Mini Tarte Sand

Ring size: 80 x 80 h 20 mm
 Mould size: 67 x 67 h 15 mm Vol.: 45 ml Cavities: 6
 25.304.13.0065

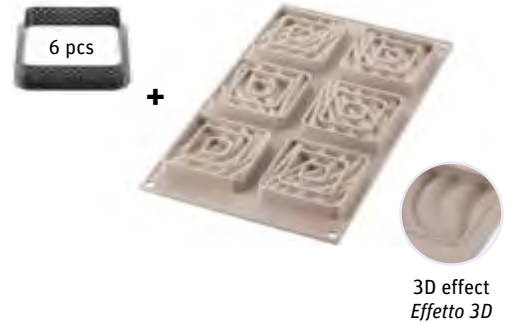

Kit Mini Tarte Glam

Ring size: Ø 80 h 20 mm
 Mould size: Ø 70 h 18 mm Vol.: 46 ml Cavities: 6
 25.293.13.0065



VOILÀ COOKIE



Voilà Cookie

Prepare in 5 seconds your perfectly shaped sweet and savory cookies.

Prepara in 5 secondi i tuoi biscotti dolci e salati dalla forma perfetta.

T PLUS

- Oven-ready special material
 - The cookies don't move or stick during the baking
 - Perfect and neat cut with every dough
 - Easy to clean
 - All the dough is used without any waste
 - Time saving, prepare your cookies in 5 seconds
-
- Speciale materiale fornabile
 - I biscotti non si muovono nè si attaccano durante la cottura
 - Taglio netto e perfetto con ogni impasto
 - Facile da pulire
 - Tutto l'impasto viene utilizzato senza sprechi
 - Salva-tempo, prepara i tuoi biscotti in 5 secondi

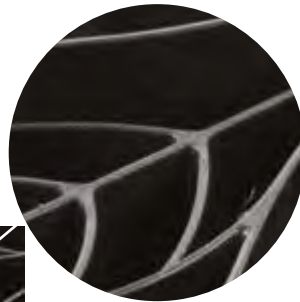
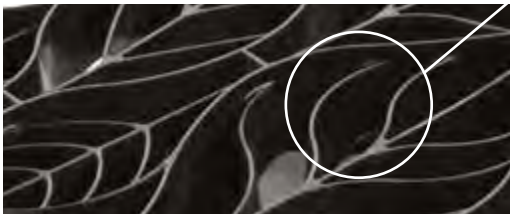

1

Press VOILÀ COOKIE over the dough.
Premere VOILÀ COOKIE sull'impasto.



2

Put VOILÀ COOKIE in the oven and bake
Mettere VOILÀ COOKIE in forno



3

Take it out from the oven and remove VOILÀ COOKIE
Sfornare e togliere VOILÀ COOKIE



Voilà Cookie - Leaves

Size: 240 x 150 h 20 mm
53.151.20.0065



Kit Voilà Cookie - Winter Holiday

Size: 47 x 49 h 20 mm
25.152.20.0065

10 Complimentary gift bags
10 Sacchetti regalo



Voilà Cookie - Love

Size: 240 x 150 h 20 mm
53.153.20.0065





Naturae[®]

HAUTE CUISINE / ALTA RISTORAZIONE

The nature as you have never seen it *La natura come non l'avete mai vista*

An original interpretation of natural elements that translates into a unique experience of taste and aesthetics.

The Naturae line was born from the creative and avant-garde vision of some of the most acclaimed chefs on the national and international scene and brings to the Ho.Re.Ca sector tools capable of combining functionality and beauty.

Naturae is not designed solely for savoury cuisine: these are nature-inspired shapes that also take centre stage in pastry-making and the art of plated desserts, giving life to exclusive creations ranging from starters to cake and modern single-portion decoration, from main courses to plated desserts with tuile or chocolate decorations.

A collection designed for professionals who want to turn every dish – savoury or sweet - into a unique and surprising masterpiece.

Una originale interpretazione degli elementi naturali che si traduce in un'inedita esperienza del gusto e dell'estetica.

La linea Naturae è nata dalla visione creativa e avanguardista di alcuni tra i più acclamati chef del panorama nazionale e internazionale e porta nel settore Ho.Re.Ca strumenti capaci di unire funzionalità e bellezza.

Naturae non è pensata solo per la ristorazione salata: sono forme ispirate alla natura che diventano protagoniste anche in pasticceria e nell'arte del dessert al piatto, dando vita a creazioni esclusive che spaziano dagli antipasti alla decorazione di torte e mono moderne, dalle portate principali ai dessert al piatto con decorazioni in tuile o cioccolato.

Una collezione progettata per i professionisti che vogliono trasformare ogni piatto - salato o dolce - in un'opera unica e sorprendente.

GLI STENCIL THE STENCILS



STENCILS

**A simple use that enhances every creation.
Flexible and adaptable to all surfaces.**

Un utilizzo semplicissimo che valorizza ogni creazione.
flessibili e adattabili a tutte le superfici.

160 mm



160 mm

SIMPLE AND IMMEDIATE USE

UTILIZZO SEMPLICE E IMMEDIATO

1. PLACE THE MAT ON THE PLATE

1. APPOGGIARE LO STENCIL SUL PIATTO

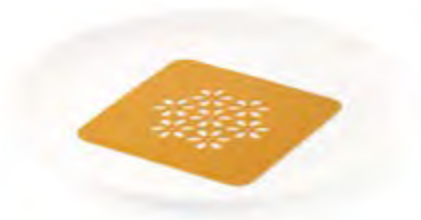

2. SPREAD THE DESIRED MIXTURE ON THE STENCIL

2. SPATOLARE IL COMPOSTO DESIDERATO
SULLO STENCIL



3. REMOVE THE STENCIL

3. RIMUOVERE LO STENCIL CON
DELICATEZZA



Stencils Conceived with
Titouan Claudet



Stencil Amore

Decor size: 100 x 98 h 1 mm

Volume: 3.9 ml

25.186.36.0065



x 2 pcs

PAIR WITH:



Truffles⁴⁰ (36.258.87.0065)
Ø 42 h 36 mm - 40 ml



Stencil Sabbia

Decor size: 101 x 101 h 1 mm

Volume: 4.4 ml

25.187.36.0065



x 2 pcs

PAIR WITH:



Lisca⁴ (33.309.36.0065)
104 x 35 h4 mm - 4 ml



Stencil Foglia

Decor size: Ø 100 h 1 mm

Volume: 2,7 ml

25.171.36.0065



x 2 pcs



Stencil Sakura

Decor size: Ø 100 h 1 mm

Volume: 3,1 ml

25.173.36.0065



x 2 pcs

PAIR WITH:



Multiflex⁴⁰ (28.145.87.4565)
Ø 45 h 25 mm - 40 ml



Stencil Cuore

Decor size: Ø 100 h 1 mm
Volume: 3,2 ml
25.172.36.0065



x 2 pcs

Stencil Palloncino

Decor size: 119 x 62 h 1 mm
Volume: 3,6 m
25.174.36.0065



x 2 pcs

PAIR WITH:



Multiflex⁴⁰ (28.145.87.4565)
Ø 45 h 25 mm - 40 ml

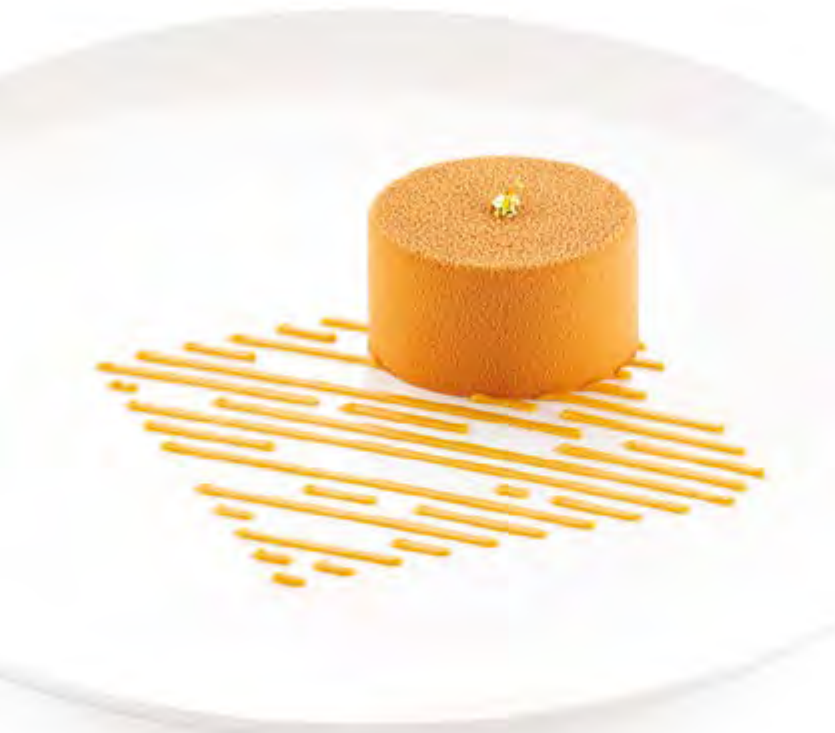

Stencil Linea

Decor size: 100 x 100 h 1 mm

Volume: 4 ml

25.176.36.0065



x 2 pcs

PAIR WITH:



Multiflex⁴⁰ (28.145.87.4565)
Ø 45 h 25 mm - 40 ml



Stencil Foliage

Decor size: 100 x 100 h 1 mm

Volume: 5 ml

25.175.36.0065



x 2 pcs



Stencil Alambra

Decor size: 100 x 100 h 1 mm
Volume: 5 ml
25.177.36.0065



x 2 pcs



Stencil Miele

Decor size: 100 x 77 h 1 mm
Volume: 3 ml
25.178.36.0065



x 2 pcs

PAIR WITH:



Multiflex⁴⁰ (28.145.87.4565)
Ø 45 h 25 mm - 40 ml



Stencil Acquerello

Decor size: 87 x 87 h 1 mm
Volume: 3.3 ml
25.185.36.0065



x 2 pcs



Stencil Arco

Decor size: 100 x 50 h 1 mm
Volume: 1.9 ml
25.184.36.0065



x 2 pcs



Stencil Galassia

Decor size: Ø 108 h 1 mm
Volume: 2.4 ml
25.179.36.0065



x 2 pcs

PAIR WITH:

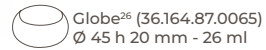

Globe[®] (36.164.87.0065)
Ø 45 h 20 mm - 26 ml



Stencil Losanga

Decor size: 137,5 x 72,3
h 1 mm
Volume: 2.5 ml
25.180.36.0065



x 2 pcs



Stencil Fiore di Loto

Decor size: Ø 100 h 1 mm

Volume: 2.4 ml

25.181.36.0065



x 2 pcs

PAIR WITH:



Airplus 17 Square (70.517.20.0298)
50 x 50 h 20 mm



Stencil Ramo

Decor size: Ø 100 h 1 mm

Volume: 3.2 ml

25.182.36.0065



x 2 pcs

PAIR WITH:



Quenelle²⁴ (36.187.87.0065)
63 x 29 h 28 mm - 24 ml

I DECORI

THE DECORS



MOULDS

Our mats from Naturae range presents always different different shapes in each mold, providing many designs only with one mould. They can be used either with "pâte à cigarette" or with chocolate for creating elegant and refined decorations. They are useful for decorating dishes, first and second courses, to create original aperitifs or to give a refined touch to plated desserts. It is also possible to cut the silicone mats following the guidelines provided, where present, for an even more practical use.

I tappeti della linea Naturae presentano sempre diverse forme in ogni stampo, offrendo numerosi design con un unico prodotto. Possono essere utilizzati sia con la pâte à cigarette sia con il cioccolato per creare decorazioni eleganti e raffinate. Sono utili per decorare antipasti, primi e secondi, per realizzare aperitivi originali o per donare un tocco ricercato ai dessert al piatto. È inoltre possibile tagliare i tappetini in silicone seguendo le linee guida riportate, dove presenti, per un uso ancora più pratico.



The size of the moulds is modular on Gastronorm trays
La dimensione degli stampi è adatta ad una teglia Gastronorm
GN 1/1 - 530 x 325 mm

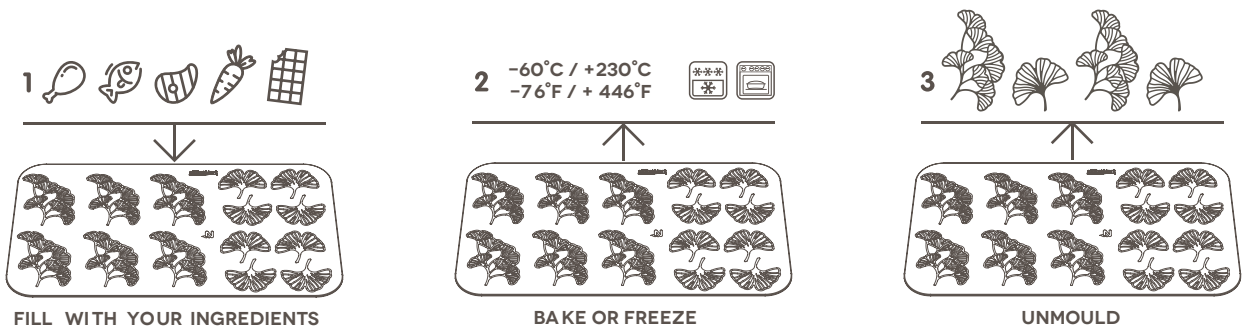



Rosmarino

Size: 93 x 43 h 1,5 mm -
75 x 38 h 1,5 mm Cavities: 28
33.326.36.0065



Ulivo

Size: 97 x 73,5 -
48,5 x 34 h 1,5 mm Cavities: 27
33.332.36.0065





Selva

Size: 34 x 35 - 22 x 41 - 36 x 31-
29,5 x 28 h 1,7 mm Cavities: 72
33.333.36.0065



Giardino

Size: 42 x 33 h 1,5 -
42 x 27 h 1,5 - 40 x 25 h 1,5 -
40 x 49 h 1,5 mm Cavities: 68
33.323.36.0065





Ginkgo

Size: 121 x 76 - 67 x 64
h 1,5 mm Cavities: 14
33.335.36.0065



Conceived with
Marcelino Gomez



Taiga

Size: 69 x 40 - 48 x 25 -
44.5 x 21 h 2 mm Cavities: 56
33.330.36.0065



Bosco

Size: 60.5 x 37 -
71 x 69 h 2 mm Cavities: 21
33.301.36.0065



Foresta

Size: 66 x 30 -
62 x 43 h 1 mm Cavities: 24
33.302.36.0065

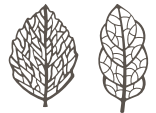



Eden

Size: 73 x 33 - 73 x 48 h 2 mm
Cavities: 24
33.312.36.0065



Spiga

Size: 55 x 17 h 2,8 mm
Cavities: 39
33.324.36.0065

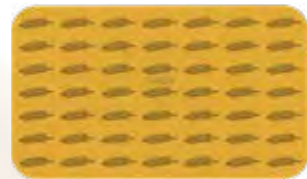

Conceived with
Andrea Berton





Inverno

Size: 67 x 47 mm / Ø 60 mm

Cavities: 24

33.325.36.0065





Margherita

Size: Ø 35 h 3.5 - Ø 27 h 3.2 -
Ø 20 h 3 - Ø 13 h 2 mm
Cavities: 76
33.331.36.0065



Conceived with
Farid Azarang
Farid Azarang



Botanica

Size: Ø 84 h 2 mm - Ø 46
h 2 mm Cavities: 34
33.316.36.0065





Arancia & Limone

Size: Ø 60 h 1,5 mm Cavities: 24
33.319.36.0065



Banana

Size: 103 x 52 - 62 x 31 h
1.5 mm Cavities: 31
33.322.36.0065





Mela & Pera

Size: 80 x 56 h 1,5 mm

60 x 51 h 2 mm

Cavities: 24

33.317.36.0065



Ventaglio

Size: 33,5 x 21,5 - 33 x

20 - 70 x 44 - 73 x 44 h

1,5 mm Cavities: 54

33.334.36.0065





Ambra

Size: Ø 68 h 1,5 mm
Cavities: 18
2833.320.36.0065

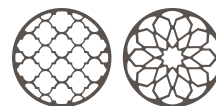

Corona

Size: Ø 68 - Ø 77 h 2 mm
Cavities: 18
33.311.36.0065





Piuma

Size: 121 x 28 - 79 x
23 h 2 mm Cavities: 20
33.314.36.0065



Lampo

Size: 131 x 26 h 2 mm
Cavities: 18
33.313.36.0065

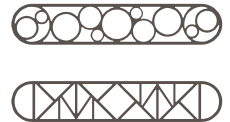



Esotico

Size: Ø 140 h 2 mm

Cavities: 2

33.327.36.0065



Mandala

Size: Ø 140 h 2 mm

Cavities: 2

33.329.36.0065

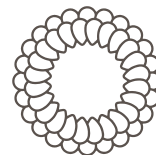



Coperto

Size: 140 x 27 h 2 mm -
140 x 19 h 2 mm Cavities: 20
33.328.36.0065



Piatto⁸⁰

Size: Ø 115 h 15 mm
Volume: 83 ml Cavities: 6
33.315.36.0065



L'ORTO

THE GARDEN





Bacello¹³

Size: 110 x 35 h 12 mm
Volume: 13 ml Cavities: 10
36.398.36.0065



Carciofo²⁸

Size: 41 x 62 h 28 mm
Volume: 28 ml Cavities: 12
36.400.36.0065





Verza¹²

Size: Ø 70 h 5 mm
Volume: 12 ml Cavities: 12
33.318.36.0065



Aglia⁴

Size: 33 x 19 h 19 mm
Volume: 4 ml Cavities: 24
36.366.36.0065





Carota²⁰

Size: 78 x 23 h 23 mm
Volume: 20 ml Cavities: 12
36.328.36.0065



Limone¹⁴

Size: 65 x 35 h 14 mm
Volume: 14 ml Cavities: 10
36.371.36.0065





Pannocchia²⁰

Size: 68 x 26 h 21 mm
Volume: 20 ml Cavities: 12
36.327.36.0065



Conceived with
Terry Giacomello



Peperoncino¹³

Size: 91 x 31 h 16 mm
Volume: 13 ml Cavities: 12
36.329.36.0065





Pomodorino¹⁴

Size: Ø 31 h 25 mm
Volume: 14 ml Cavities: 18
36.376.36.0065

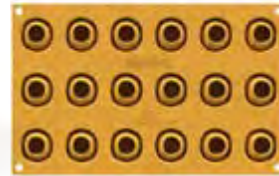

Pomodoro²⁴

Size: Ø 43 h 28 mm
Volume: 24 ml Cavities: 12
36.330.36.0065



LA TERRA

THE LAND





Porcino

Size: 36 x 59 h 18 mm

46 x 53 h 22 mm

Volume: 13 - 20 ml Cavities: 16

36.401.36.0065



Tortellino²⁰

Size: Ø 54 h 22 mm

Volume: 20 ml Cavities: 8

36.367.36.0065





Michetta⁹²

Size: Ø 64 h 45 mm

Volume Top: 45 ml

Volume Base: 48 ml Cavities: 8

36.356.36.0065



Conceived with
Cristina Bowerman

Cristina Bowerman



Femore³²

Size: 31 x 90 h 26 mm

Volume: 32 ml Cavities: 9

36.350.36.0065





Milanese²⁵

Size: 51,5 x 52 h 18,5 -
45 x 57 h 18,5 - 52,5 x 50 h 18,5
Volume: 25 ml Cavities: 112
36.348.36.0065



Erbetta⁴³

Size: Ø 100 h 8 mm
Volume: 43 ml Cavities: 8
33.310.36.0065



IL MARE

THE SEA





Granchio⁶

Size: 61 x 41 h 7 mm
Volume: 12 ml Cavities: 12
36.419.36.0065

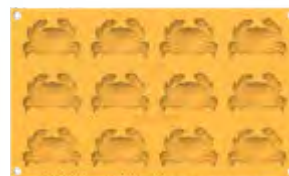

Conceived with
Kazuyuki Tanaka

情熱
Tanaka



Corallo

Size: 68 x 63 - 50 x
63 h 1,5 mm Cavities: 21
33.321.36.0065





Canestrello¹⁵

Size: 72 x 65 h 8 mm
Volume: 15 ml Cavities: 8
36.399.36.0065



Polpo²⁰

Size: 60 x 55 h 20 mm
Volume: 20 ml Cavities: 12
36.357.36.0065





Scampo²⁰

Size: 81x 42 h 14 mm
Volume: 20 ml Cavities: 12
36.349.36.0065



Lisca⁴

Size: 104 x 35 h 4 mm
Volume: 4 ml Cavities: 16
33.309.36.0065



LA GEOMETRIA

THE GEOMETRY



Pois

Size: Ø 20 - 35 - 45 h 8 mm

Volume: 2,2- 7,2 - 12 ml

Cavities: 26

36.483.36.0065



Conceived with
Michele Abbatemarco

Michele Abbatemarco



Cerchio 3.0

Size: Ø 22 - 58 - 100 h 5,5 mm
Volume: 2 - 11 - 25 ml Cavities: 27
33.303.36.0065



Cerchio 4.0

Size: Ø 100 h 5,5 mm
Volume: 40 ml Cavities: 27
33.304.36.0065





Quadrato 3.0

Size: 20 x 20 - 56 x 56

98 x 98 h 5,5 ml

Volume: 2 - 12 - 30 Cavities: 24

33.305.36.0065



Quadrato 4.0

Size: 48,5 x 48,5 h 5,5 mm

Volume: 12,5 ml Cavities: 32

33.306.36.0065





Triangolo 2.0

Size: 110,5 x 97
42,41 x 37,6 h 5,5 mm
Volume: 25 - 5 ml Cavities: 24
33.308.36.0065



Triangolo 3.0

Size: 103 x 95 h 5,5 mm
Volume: 10,5 ml Cavities: 36
33.307.36.0065



Ice²⁶

Size: 30 x 30 h 30 mm
Volume: 26 ml Cavities: 25
70.008.36.0065

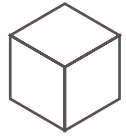

FELIX





Felix

Size: 181 x 237 h 71,5 mm

Volume: 1500 - 1560 ml

70.150.36.0062



500 / 750 g
17.63 / 26.45 oz



Conceived with
**Tommaso
Foglia**



SILICONE BASKET FOR LEAVENING DOUGHS AND BREAD

- Totally hygienic
- Dishwasher-safe
- Micro holes for the evaporation of humidity
- Stackable
- Non-stick
- Providing the ideal conditions the bread dough needs before baking to develop properly
- Promoting the fermentation process by providing the dough with sufficient oxygen, which makes the bread soft and airy
- Suitable for use in both the oven +230°C/+446°F and blast chiller -60°C/-76°F.

CESTINO IN SILICONE PER LA LIEVITAZIONE DI IMPASTI E PANE

- Totalmente igienico
- Lavabile in lavastoviglie
- Microfori per l'evaporazione dell'umidità
- Impilabile
- Antiaderente
- Garantisce le condizioni ideali di cui ha bisogno l'impasto del pane prima della cottura per potersi sviluppare correttamente
- Favorisce il processo di fermentazione fornendo all'impasto ossigeno sufficiente, e questo rende il pane soffice e arioso
- Adatto sia per l'uso in forno +230°C che in abbattitore -60°C.

Tappeto Antiscivolo 30x40 cm

Size: 300 x 400 h 1,5 mm
33.018.36.0062

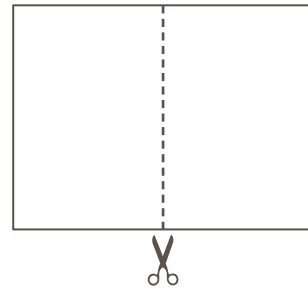

This 30x40 cm non-slip Mat is an essential ally in hotel and restaurant kitchens, as well as at home.

The two polished sides ensure 100% adherence to surfaces, making the use of knives and other blades safer. The cutting guide on the back of the item allows the mat to be divided in half to perfectly adapt to kitchen needs.

Il Tappeto Antiscivolo 30x40 cm è un alleato indispensabile nelle cucine di hotel, ristoranti e anche in casa.

I due lati lucidati garantiscono una aderenza del 100% alle superfici, rendendo più sicuro l'utilizzo di coltelli e di altre lame. L'invito al taglio sul retro dell'articolo consente di dividere il tappeto a metà per adattarsi perfettamente alle esigenze in cucina.

CHOCOLATE SOLUTIONS

SOLUZIONI PER IL CIOCCOLATO

chocado



CHOCO STAMP

A kit comprising 4 plastic handles and 4 silicone stamps to create original decorations on our Semisfera 01-P mould.

- 1 PRODUCT – 4 DIFFERENT DESIGNS
- The handle fits perfectly into the square cavity of the stamp, providing maximum stability during decoration.
- Original designs developed in collaboration with Lluç Crusellas, winner of the 2022 World Chocolate Masters.

Un kit composto da 4 manici in plastica e 4 timbri in silicone per creare originali decorazioni sul nostro stampo Semisfera 01-P

- 1 PRODOTTO - 4 DESIGN DIVERSI.
- Il manico si inserisce perfettamente nella cavità quadrata presente sul timbro, dando così massima stabilità in fase di decorazione.
- Originali design sviluppati in collaborazione con il vincitore dei World Chocolate Masters 2022 Lluç Crusellas.

Lluç Crusellas

How to use
Utilizzo



The handle perfectly matches the square cavity of the silicone stamp for perfect stability when decorating.
Il manico si inserisce perfettamente nella cavità quadrata presente sul timbro, dando così massima stabilità in fase di decorazione.

HOW TO USE: / MODO D'USO:

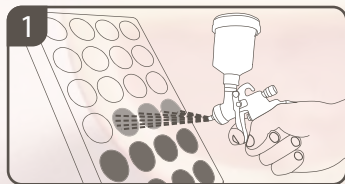

SPRAY / SPRUZZARE

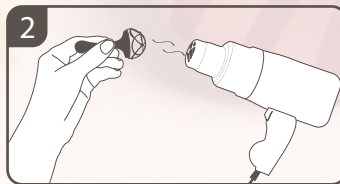

HEAT / SCALDARE



STAMP / TIMBRARE



**CLEAN WITH THE SPONGE /
PULIRE CON LA SPUGNA**

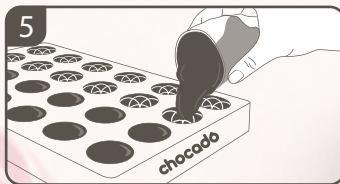

FILL / RIEMPIRE

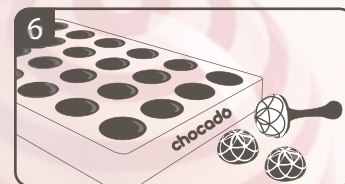

SFORMARE / UNMOULD

Semisfera01 & Choco Stamp A

25.913.86.0065

Vol. 8,5 ml

Silicone stamp size:
Ø 31 h 17 mm

Praline Size:
Ø 31 h 16,5 mm
24 Pralines / Mould



1 Tritan™ Mould

+

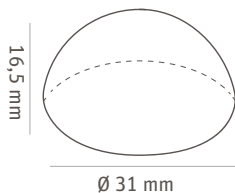

4 different silicone stamps + 4 handles
4 diversi timbri in silicone + 4 manici



Choco Stamp A

Silicone stamp size: Ø 31 h 17 mm
25.153.02.0065

Set of 4 different silicone stamps + 4 handles.
Set di 4 diversi timbri in silicone + 4 manici.

To customize pralines made with
our Semisfera 01 mould.
*Per decorare le praline create con
lo stampo Semisfera 01.*



Semisfera01 & Choco Stamp B

25.914.86.0065

Vol. 8,5 ml

Silicone stamp size:

Ø 31 h 19 mm

Praline Size:

Ø 31 h 16,5 mm

24 Pralines / Mould



1 Tritan™ Mould

+

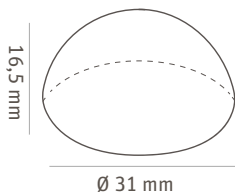

4 different silicone stamps + 4 handles
4 diversi timbri in silicone + 4 manici

Choco Stamp B

Silicone stamp size: Ø 31 h 19 mm

25.154.02.0065

Set of 4 different silicone stamps + 4 handles.

Set di 4 diversi timbri in silicone + 4 manici.

To customize pralines made with our Semisfera 01 mould.

Per decorare le praline create con lo stampo Semisfera 01.



Semisfera01 & Choco Stamp C

25.915.86.0065

Vol. 8,5 ml

Silicone stamp size:
Ø 31 h 19 mm

Praline Size:
Ø 31 h 16,5 mm
24 Pralines / Mould



1 Tritan™ Mould

+

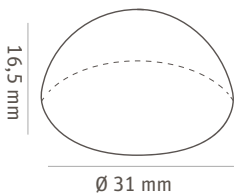

4 different silicone stamps + 4 handles
4 diversi timbri in silicone + 4 manici

Choco Stamp C

Silicone stamp size: Ø 31 h 19 mm
25.155.02.0065

Set of 4 different silicone stamps + 4 handles.
Set di 4 diversi timbri in silicone + 4 manici.

To customize pralines made with
our Semisfera 01 mould.
*Per decorare le praline create con
lo stampo Semisfera 01.*



Uovo01 & Choco Stamp E

25.916.86.0065

Vol. 8 ml

Silicone stamp size:
42 x 30 h 16,5 mm

Praline Size:
40 x 28 h 14 mm
24 Pralines / Mould



1 Tritan™ Mould

+

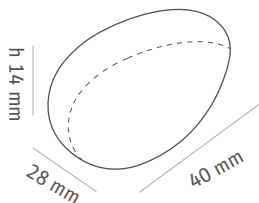

4 different silicone stamps + 4 handles
4 diversi timbri in silicone + 4 manici



Choco Stamp E

Silicone stamp size: 42 x 30 h 16,5 mm
25.156.02.0065

Set of 4 different silicone stamps + 4 handles.
Set di 4 diversi timbri in silicone + 4 manici.



High-quality moulds for fine chocolates

Stampi di qualità per l'alta cioccolateria



The Chocado range brings all of Silikomart's expertise and the well-established qualities of materials such as Tritan™ and platinum silicone to the world of fine chocolate-making. Durability, resistance and reliable performance over time are the pillars on which this collection is built, designed to support chocolatiers and artisans in creating unique products.

Main features

Chocado moulds are made from Tritan™, a material that represents an evolution compared to traditional plastics:

- Durability: resists impacts and frequent washing, maintaining its properties unchanged even after years of use.
- Safety: free from PFAS, BPA, BPS and other bisphenols, perfectly suitable for food contact.
- Purity and resistance: guarantees superior performance and consistent reliability over time.
- Lightweight: lightweight moulds to make every process easier.
- Aesthetic: ensures glossy results without additional effort.

Versatility and reliability

With Chocado, creative possibilities in chocolate-making expand: many shapes can be combined with silicone moulds, allowing perfect inserts to be created. New textures and flavours can be experimented with, giving life to original creations. This results in versatile products, such as summer chocolates, ideal even during periods when traditional chocolate consumption tends to decrease. Every mould guarantees a glossy finish and an impeccable shape, thanks to easy unmoulding.

tritan™
from eastman

PFAS FREE  **BPA FREE**

La linea chocado porta nell'alta cioccolateria tutta l'esperienza di Silikomart e le qualità ormai consolidate di materiali come tritan™ e il silicone platinum. Durevolezza, resistenza e performance affidabili nel tempo sono i pilastri su cui si fonda questa collezione, pensata per accompagnare i cioccolatieri e gli artigiani nella creazione di prodotti unici.

Caratteristiche principali

Gli stampi chocado sono realizzati in tritan™, un materiale che rappresenta un'evoluzione rispetto alle plastiche tradizionali:

- Durata: resiste agli urti e ai lavaggi frequenti, mantenendo le sue proprietà inalterate anche dopo anni di utilizzo.
- Sicurezza: privo di pfas, bpa, bps e altri bisfenoli, è perfettamente idoneo al contatto con gli alimenti.
- Purezza e resistenza: garantisce performance superiori e affidabilità costante nel tempo.
- Leggerezza: stampi leggeri per facilitare ogni lavorazione
- Estetica: garantisce risultati lucidi senza sforzi ulteriori

Versatilità e affidabilità

Con chocado si ampliano le possibilità creative nella lavorazione del cioccolato: molte forme si abbinano agli stampi in silicone, permettendo di realizzare inserti perfetti. Si possono sperimentare nuove consistenze e sapori, dando vita a creazioni originali. Nascono così prodotti versatili, come i cioccolatini estivi, ideali anche nei periodi in cui il consumo di cioccolato tradizionale tende a diminuire. Ogni stampo garantisce una resa lucida e una forma impeccabile, grazie alla sformatura facilitata.



Christmas Countdown

25.945.86.0065

Vol. 9 ml

Chocolate Size:
82 x 12 h 10 mm
24 Chocolates / Mould



1 Tritan™ Mould



1 Gift box
Advent
Calendar
+
2 Thermoformed
Supports



Watch the video tutorial
Guarda il video tutorial

CHRISTMAS COUNTDOWN BOX REFILLS

Set 2 pcs
22.487.02.0060

Set 20 pcs
22.487.20.0001

2 Gift Boxes
4 Thermoformed
Supports

20 Gift Boxes
40 Thermoformed
Supports

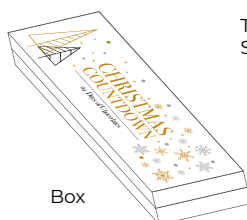

Box

Thermoformed
Supports

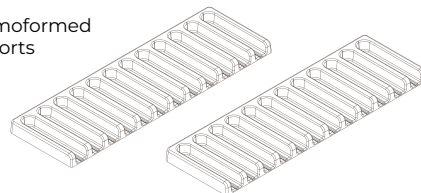

Chocado kits combine two premium materials:

Tritan, which is both durable and flexible, delivers exceptionally glossy finishes, while platinum silicone streamlines the creation of inserts to be added during assembly, optimizing the production process and ensuring flawless results.

I kit Chocado uniscono due materiali di altissima qualità:

il Tritan, resistente e flessibile, assicura finiture estremamente brillanti, mentre il silicone platinum semplifica la realizzazione degli inserti da aggiungere in fase di assemblaggio, ottimizzando il processo produttivo e garantendo risultati impeccabili.



Kit BonBon Ice

52.950.86.0065

Vol. 33 ml

Top/Base size:

Ø 44 h 5,5 mm

Insert Size: Ø 44 h 14 mm

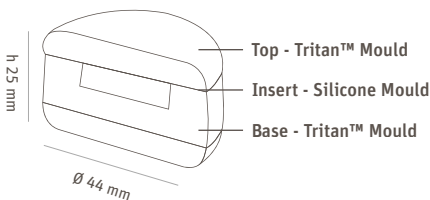

Tritan™ Mould

+



Platinum Silicone Mould



Prodotto correlato / Related product:

MACADÒ 6 pcs 72.351.86.0000 / 12 pcs 72.352.86.0000



Tritan™ Mould

+



Platinum Silicone Mould

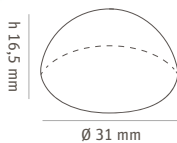

Ø 31 mm

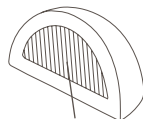

Insert

Kit Semisfera 01

52.913.86.0065

Vol. 8,5 ml

Praline Size:
Ø 31 mm h 16,5 mm
24 Pralines / Mould

Insert Size:
Ø 22 h 11 mm
Volume: 2,8 ml

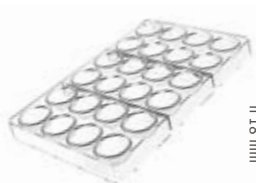

Tritan™ Mould

+



Platinum Silicone Mould

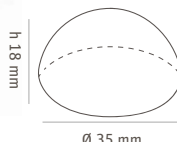

Ø 35 mm

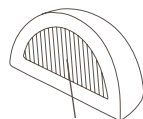

Insert

Kit Semisfera 02

52.937.86.0065

Vol. 12 ml

Praline Size:
Ø 35 h 18 mm
24 Pralines / Mould

Insert Size:
Ø 25,8 h 11,5 mm
Volume: 3,8 ml



Tritan™ Mould

+



Platinum Silicone Mould

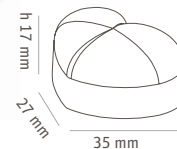

35 mm

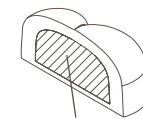

Insert

Kit Cuore 01

52.920.86.0065

Vol. 9,4 ml

Praline Size:
35 x 27 h 17 mm
24 Pralines / Mould

Insert Size:
25,5 x 20 h 12,4 mm
Volume: 3,5 ml



Kit Dome 01

52.930.86.0065

Vol. 8 ml

Praline size:
Ø 26 h 22 mm
24 Pralines / Mould

Insert Size:
Ø 18 h 16,3 mm
Volume: 2,5 ml



Kit Ovale 01

52.914.86.0065

Vol. 8,5 ml

Praline size:
23 x 33 h 15 mm
24 Pralines / Mould

Insert Size:
24 x 14 h 10 mm
Volume: 2,5 ml



Kit Quadro 01

52.915.86.0065

Vol. 8,9 ml

Praline size:
25 x 25 h 15 mm
24 Pralines / Mould

Insert Size:
16 x 16 h 10 mm
Volume: 2,4 ml



Tritan™ Mould

+



Platinum Silicone Mould

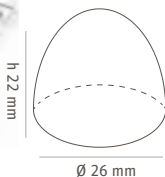

Ø 26 mm

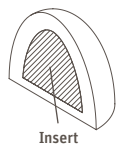

Insert



Tritan™ Mould

+



Platinum Silicone Mould

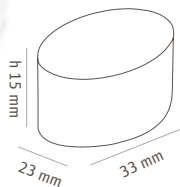

23 mm

33 mm

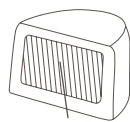

Insert



Tritan™ Mould

+

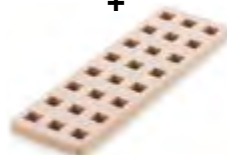

Platinum Silicone Mould

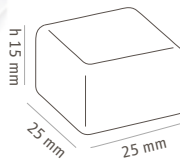

25 mm

25 mm

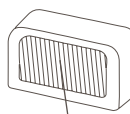

Insert



Tritan™ Mould

+



Platinum Silicone Mould

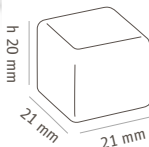

h 20 mm

21 mm

21 mm



Insert

Kit Cubo 01

52.929.86.0065

Vol. 8,5 ml

Praline size:
21 x 21 h 20 mm
24 Pralines / Mould

Insert Size:
13 x 13 h 14 mm
Volume: 2,3 ml



Tritan™ Mould

+



Platinum Silicone Mould

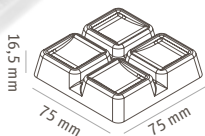

h 16,5 mm

75 mm

75 mm

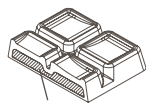

Insert

Kit Blocco -T

52.921.86.0065

Vol. 77 ml

Snack Bar Size:
75 x 75 h 16,5 mm
6 Blocks / Mould

Insert Size:
67 x 67 h 7,5 mm
Volume: 27,5 ml



Tritan™ Mould

+



Platinum Silicone Mould

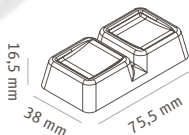

h 16,5 mm

38 mm

75,5 mm

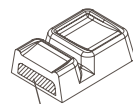

Insert

Kit Blocco -B

52.922.86.0065

Vol. 38,5 ml

Snack Bar Size:
75,5 x 38 h 16,5 mm
10 Snack Bars / Mould

Insert Size:
66 x 28,5 h 7,5 mm
Volume: 12 ml





Tritan™ Mould

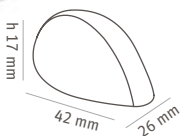

+



Platinum Silicone Mould



Insert

Kit Quenelle 01

52.938.86.0065

Vol. 8 ml

Praline Size:
42 x 26 h 17 mm
24 Pralines / Mould

Insert Size:
30,7 x 17,2 h 10,7 mm
Volume: 2,4 ml



Tritan™ Mould

+



Platinum Silicone Mould

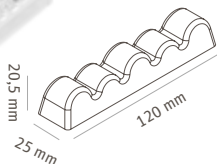

Insert

Kit Sinfonia ^B

52.924.86.0065

Vol. 42 ml

Snack Bar Size:
120 x 25 h 20,5 mm
10 Snack Bars / Mould

Insert Size:
109 x 18 h 13,5 mm
Volume: 14,5 ml



Tritan™ Mould

+



Platinum Silicone Mould

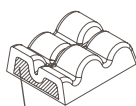
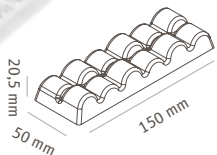

Insert

Kit Sinfonia ^T

52.923.86.0065

Vol. 107 ml

Snack Bar Size:
150 x 50 h 20,5 mm
4 Tablettes / Mould

Insert Size:
138 x 38,5 h 13,6 mm
Volume: 32 ml



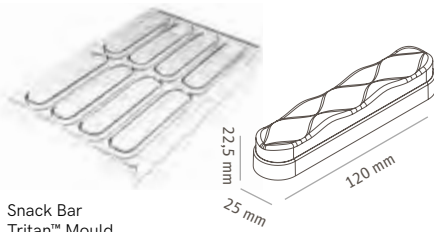

Snack Bar
Tritan™ Mould

+



Top
Platinum Silicone Mould

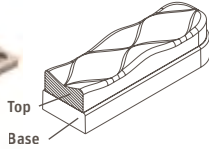

Kit Bar Sisma

52.993.86.0065

Vol. 52 ml

Snack Bar Size:
120 x 25 h 10 mm
8 Snack Bars / Mould

Top Size:
117 x 22 h 12,5 mm
Volume: 23 ml

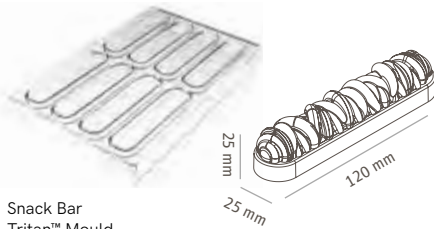

Snack Bar
Tritan™ Mould

+



Top
Platinum Silicone Mould

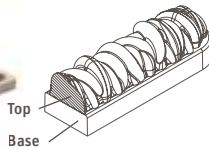

Kit Bar Magma

52.994.86.0065

Vol. 53 ml

Snack Bar Size:
120 x 25 h 10 mm
8 Snack Bars / Mould

Top Size:
116,5 x 23 h 15 mm
Volume: 24 ml

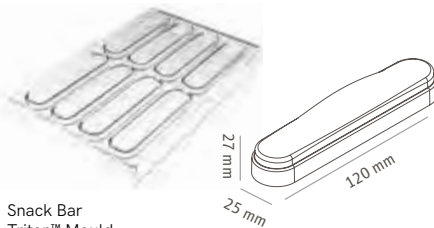

Snack Bar
Tritan™ Mould

+



Top
Platinum Silicone Mould

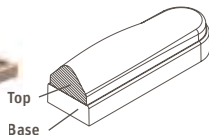

Kit Bar Vulcano

52.995.86.0065

Vol. 53 ml

Snack Bar Size:
120 x 25 h 10 mm
8 Snack Bars / Mould

Top Size:
117 x 22 h 17 mm
Volume: 23 ml



Kit Bar Tronco

52.916.86.0065

Vol. 48 ml

Snack Bar Size:
120 x 25 h 10 mm
8 Snack Bars / Mould

Top Size:
115 x 20 h 13 mm
Volume: 19 ml

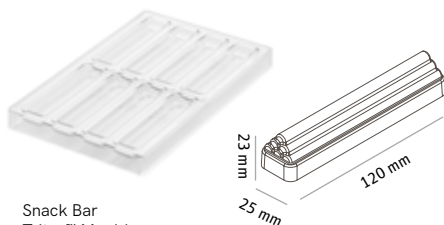

Snack Bar
Tritan™ Mould

+

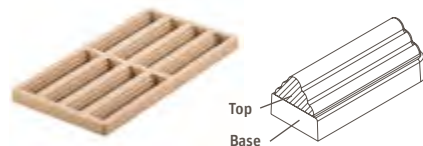

Top
Platinum Silicone Mould



Kit Bar Volta

52.991.86.0065

Vol. 52,5 ml

Snack Bar Size:
120 x 25 h 10 mm
8 Snack Bars / Mould

Top Size:
115 x 20 h 13 mm
Volume: 23,5 ml

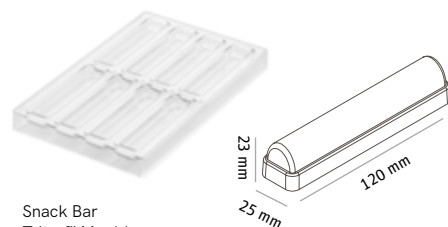

Snack Bar
Tritan™ Mould

+

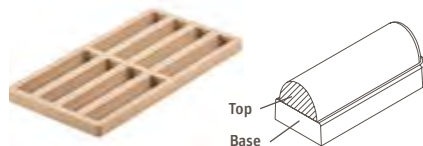

Top
Platinum Silicone Mould



Kit Bar Duna

52.992.86.0065

Vol. 57 ml

Snack Bar Size:
120 x 25 h 10 mm
8 Snack Bars / Mould

Top Size:
115 x 20 h 13 mm
Volume: 28 ml

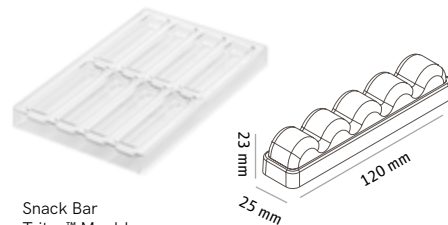

Snack Bar
Tritan™ Mould

+

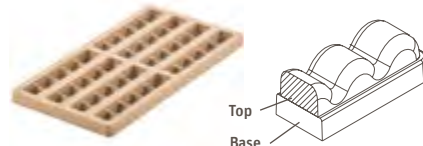

Top
Platinum Silicone Mould





Tritan™ Mould

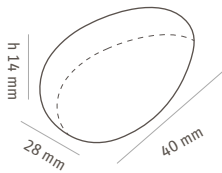

Uovo 01 - P

52.952.86.0065

Vol. 8 ml

Praline Size:
40 x 28 h 14 mm
24 Pralines / Mould

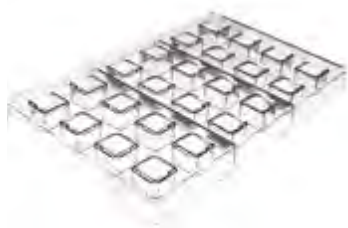

Tritan™ Mould

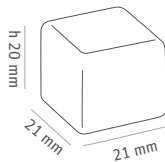

Cubo 01 - P

52.929.86.0165

Vol. 8,5 ml

Praline size:
21 x 21 h 20 mm
24 Pralines / Mould





Tritan™ Mould

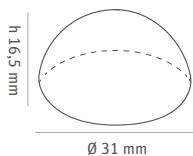

Semisfera 01 - P

52.913.86.0165

Vol. 8,5 ml

Praline size:
Ø 31 h 16,5 mm
24 Pralines / Mould



Tritan™ Mould

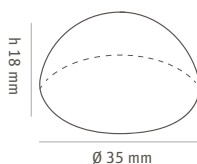

Semisfera 02 - P

52.937.86.0165

Vol. 12 ml

Praline Size:
Ø 35 h 18 mm
24 Pralines / Mould



Tritan™ Mould

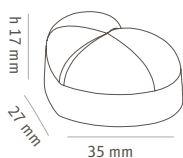

Cuore 01 - P

52.920.86.0165

Vol. 9,4 ml

Praline Size:
35 x 27 h 17 mm
24 Pralines / Mould





Tritan™ Mould

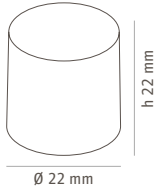

Cilindro 01 - P

52.946.86.0065

Vol. 8 ml

Praline size:
Ø 22 h 22 mm
24 Pralines / Mould



Tritan™ Mould

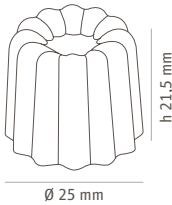

Cannelé 01 - P

52.951.86.0065

Vol. 8 ml

Praline size:
Ø 25 h 21,5 mm
24 Pralines / Mould



Conceived with
Xavi Donnay

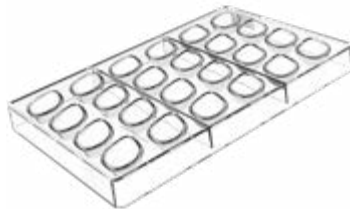

Tritan™ Mould

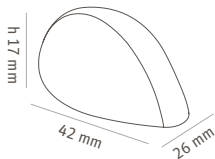

Quenelle 01 - P

52.938.86.0165

Vol. 8 ml

Praline size:
42 x 26 h 17 mm
24 Pralines / Mould





Tritan™ Mould

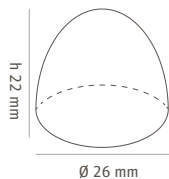

Dome 01 -^P

52.930.86.0165

Vol. 8 ml

Praline size:
Ø 26 h 22,5 mm
24 Pralines / Mould



Tritan™ Mould

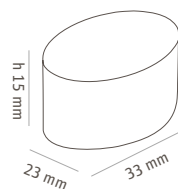

Ovale 01 -^P

52.914.86.0165

Vol. 8,5 ml

Praline size:
23 x 33 h 15 mm
24 Pralines / Mould



Tritan™ Mould

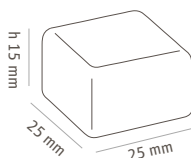

Quadro 01 -^P

52.915.86.0165

Vol. 8,5 ml

Praline size:
25 x 25 h 15 mm
24 Pralines / Mould





Tritan™ Mould

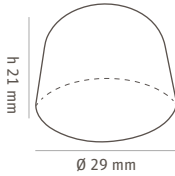

Vintage 01 - P

52.956.86.0065

Vol. 10 ml

Praline size:
Ø 29 h 21 mm
24 Pralines / Mould

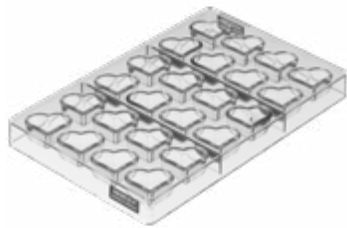

Tritan™ Mould

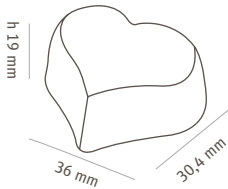

Amore 01 - P

52.958.86.0065

Vol. 10,8 ml

Praline size:
36 x 30,4 h 19 mm
24 Pralines / Mould



Tritan™ Mould

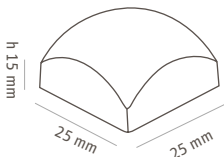

Domus 01 - P

52.957.86.0065

Vol. 7,2 ml

Praline size:
25 x 25 h 15 mm
24 Pralines / Mould





Tritan™ Mould

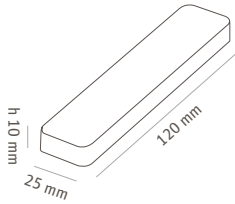

Snack Bar 01

52.916.86.0065

Vol. 29 ml

Snack Bar Size:
120 x 25 h 10 mm
8 Snack Bars / Mould



Tritan™ Mould

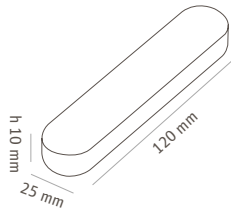

Snack Bar 02

52.928.86.0065

Vol. 29 ml

Snack Bar Size:
120 x 25 h 10 mm
8 Snack Bars / Mould



Tritan™ Mould

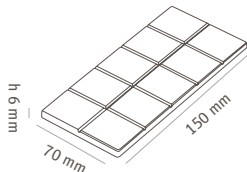

Classica -T

52.953.86.0065

Vol. 62 ml

Tablette Size:
150 x 70 h 6 mm
3 Tablettes / Mould

Conceived with
Gian Luca Forino





Tritan™ Mould

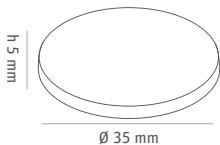

Degusta 01 - P

52.927.86.0065

Vol. 3,2 ml

Praline Size:
Ø 35 h 5 mm
15 Pralines / Mould



Conceived with
Luca Bernardini



Tritan™ Mould

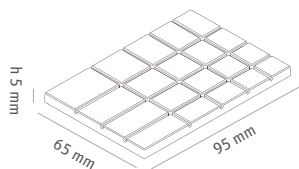

Degusta 01 - T

52.925.86.0065

Vol. 30 ml

Tablette Size:
95 x 65 h 5 mm
4 Tablettes / Mould



Degusta 02 - T

52.926.86.0065

Vol. 30 ml

Tablette Size:
95 x 65 h 5 mm
4 Tablettes / Mould



Tritan™ Mould

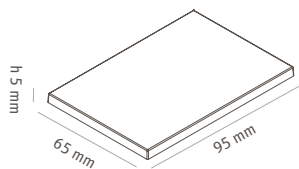



Tritan™ Mould

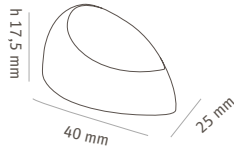

Aurora -P

52.947.86.0065

Vol. 8 ml

Praline Size:
40 x 25 h 17,5 mm
24 Pralines / Mould



Conceived with
Florent Margaillan



Tritan™ Mould

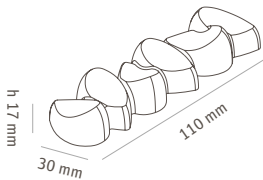

Aurora -B

52.948.86.0065

Vol. 29 ml

Snack Bar Size:
110 x 30 h 17 mm
8 Snack Bars / Mould



Conceived with
Florent Margaillan



Tritan™ Mould

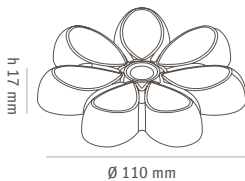

Aurora -T

52.949.86.0065

Vol. 29 ml

Tablette Size:
Ø 110 h 17 mm
2 Tablettes / Mould



Conceived with
Florent Margaillan





Double-textured Tritan™ Mould

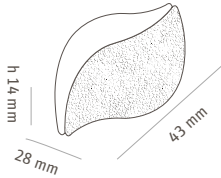

Riflesso -P

52.939.86.0065

Vol. 8 ml

Praline Size:
43 x 28 h 14 mm
24 Pralines / Mould



Conceived with
Lluc Crusellas

Lluc Crusellas



Double-textured Tritan™ Mould

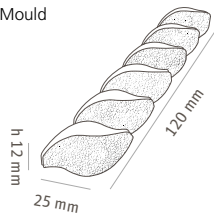

Riflesso -B

52.940.86.0065

Vol. 25 ml

Snack Bar Size:
120 x 25 h 12 mm
8 Snack Bars / Mould



Conceived with
Lluc Crusellas

Lluc Crusellas



Double-textured Tritan™ Mould

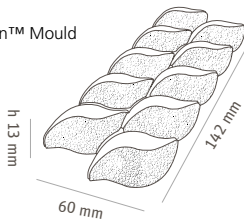

Riflesso -T

52.941.86.0065

Vol. 77 ml

Tablette Size:
142 x 60 h 13 mm
3 Tablettes / Mould



Conceived with
Lluc Crusellas

Lluc Crusellas



Double-textured Tritan™ Mould

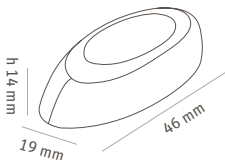

Sogno -P

52.942.86.0065

Vol. 8 ml

Praline Size:
46 x 19 h 14 mm
24 Pralines / Mould



Double-textured Tritan™ Mould

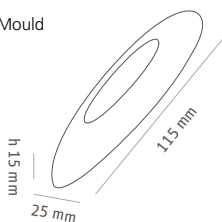

Sogno -B

52.943.86.0065

Vol. 28 ml

Snack Bar Size:
115 x 25 h 15 mm
10 Snack Bars / Mould



Double-textured Tritan™ Mould

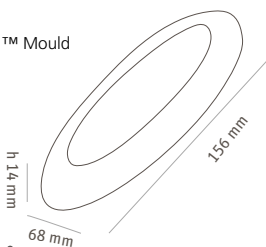

Sogno -T

52.944.86.0065

Vol. 82 ml

Tablette Size:
156 x 58 h 14 mm
4 Tablettes / Mould





Tritan™ Mould

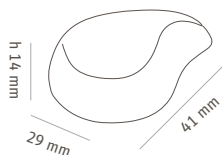

Goccia - P

52.907.86.0065

Vol. 8 ml

Praline Size:
29 x 41 h 14 mm
24 Pralines / Mould



Conceived with
Kirsten Tibballs



Tritan™ Mould

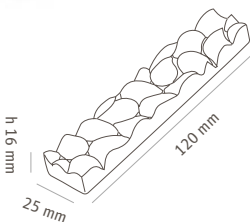

Goccia - B

52.909.86.0065

Vol. 30 ml

Snack Bar Size:
120 x 25 h 16 mm
8 Snack Bars / Mould



Conceived with
Kirsten Tibballs



Tritan™ Mould

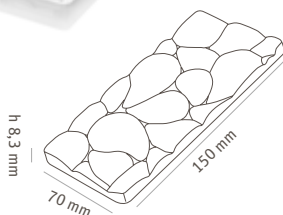

Goccia - T

52.908.86.0065

Vol. 80 ml

Tablette Size:
150 x 70 h 8,3 mm
3 Tablettes / Mould



Conceived with
Kirsten Tibballs



Tritan™ Mould

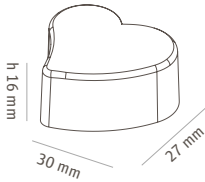

Tesoro - P

52.934.86.0065

Vol. 8 ml

Praline Size:
30 x 27 h 16 mm
24 Pralines / Mould



Conceived with
Kirsten Tibballs



Tritan™ Mould

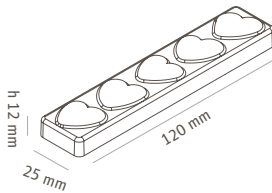

Tesoro - B

52.935.86.0065

Vol. 30 ml

Snack Bar Size:
120 x 25 h 12 mm
8 Snack Bars / Mould



Conceived with
Kirsten Tibballs



Tritan™ Mould

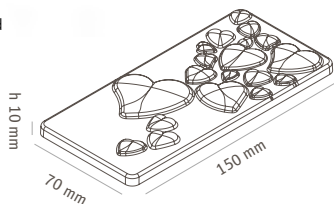

Tesoro - T

52.936.86.0065

Vol. 74 ml

Tablette Size:
150 x 70 h 10 mm
3 Tablettes / Mould



Conceived with
Kirsten Tibballs



Tritan™ Mould

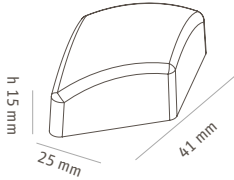

Gemma -^P

52.931.86.0065

Vol. 7,8 ml

Praline Size:
41 x 25 h 15 mm
24 Pralines / Mould



Tritan™ Mould

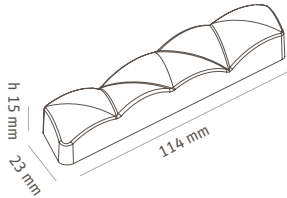

Gemma -^B

52.932.86.0065

Vol. 30 ml

Snack Bar Size:
114 x 23 h 15 mm
10 Snack Bars / Mould



Tritan™ Mould

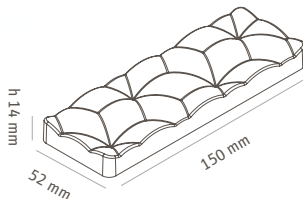

Gemma -^T

52.933.86.0065

Vol. 92,5 ml

Tablette Size:
150 x 52 h 14 mm
4 Tablettes / Mould





Tritan™ Mould

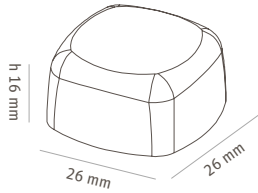

Cupola - P

52.917.86.0065

Vol. 8 ml

Praline Size:
26 x 26 h 16 mm
24 Pralines / Mould



Tritan™ Mould

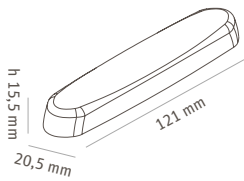

Cupola - B

52.918.86.0065

Vol. 27 ml

Snack Bar Size:
121 x 20,5 h 15,5 mm
8 Snack Bars / Mould



Tritan™ Mould

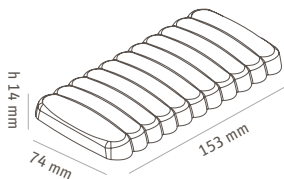

Cupola - T

52.919.86.0065

Vol. 117 ml

Tablette Size:
153 x 74 h 14 mm
3 Tablettes / Mould





Tritan™ Mould

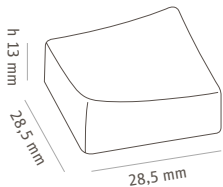

Onda -P

52.901.86.0065

Vol. 8 ml

Praline Size:
28,5 x 28,5 h 13 mm
24 Pralines / Mould



Conceived with
David Vidal



Tritan™ Mould

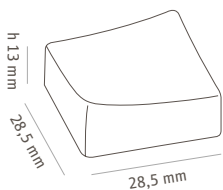

Onda -B

52.903.86.0065

Vol. 26 ml

Snack Bar Size:
120 x 20 h 15 mm
10 Snack Bars / Mould



Conceived with
David Vidal



Tritan™ Mould

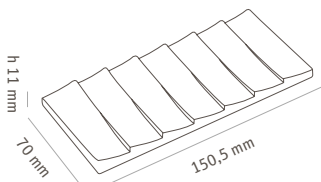

Onda -T

52.902.86.0065

Vol. 85 ml

Tablette Size:
150,5 x 70 h 11 mm
3 Tablettes / Mould



Conceived with
David Vidal



Tritan™ Mould

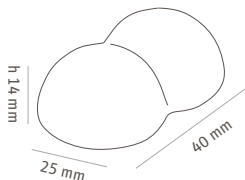

Bolla -P

52.910.86.0065

Vol. 8 ml

Praline Size:
25 x 40 h 14 mm
24 Pralines / Mould



Tritan™ Mould

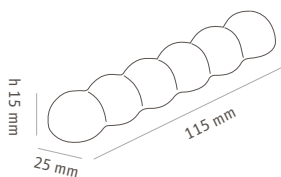

Bolla -B

52.912.86.0065

Vol. 28 ml

Snack Bar Size:
115 x 25 h 15 mm
10 Snack Bars / Mould



Tritan™ Mould

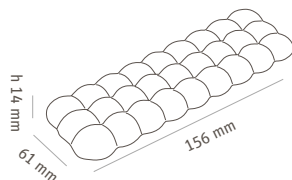

Bolla -T

52.911.86.0065

Vol. 68 ml

Tablette Size:
156 x 61 h 14 mm
4 Tablettes / Mould





Tritan™ Mould

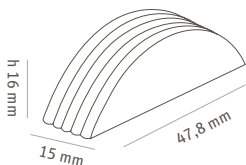

Riga -^P

52.904.86.0065

Vol. 8 ml

Praline Size:
47,8 x 15 h 16 mm
24 Pralines / Mould



Tritan™ Mould

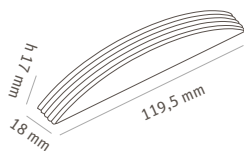

Riga -^B

52.906.86.0065

Vol. 8 ml

Snack Bar Size:
119,5 x 18 h 17 mm
10 Snack Bars / Mould



Tritan™ Mould

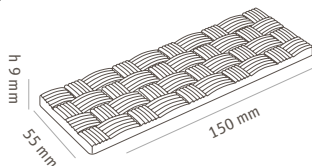

Riga -^T

52.905.86.0065

Vol. 68 ml

Tablette Size:
150 x 55 h 9 mm
4 Tablettes / Mould



3D THERMOFORMED CHOCO FIGURES

TERMOFORMATI 3D CHOCO FIGURES

The 3D thermoformed Choco Figures moulds are the ideal solution for creating three-dimensional chocolate subjects. With figures designed for every theme and season, they bring the sweetness and intensity of chocolate to every special occasion, ensuring flawless results. The finishing touch is personalisation, entrusted to the flair and creativity of the chocolatier.

Gli stampi termoformati 3D Choco Figures sono la soluzione ideale per creare soggetti di cioccolato tridimensionali. Con figure pensate per ogni tema e stagione, portano la dolcezza e l'intensità del cioccolato in ogni occasione speciale, assicurando risultati impeccabili. A completare l'opera resta solo la personalizzazione, affidata all'estro e alla creatività del cioccolatiere.





Winter Joy

Size: Ø 110 h 160 mm

70.615.99.0065

Set 2 Moulds



Kit Rudolf

Size: 147 h 236 mm

70.105.99.0065

Set 5 Moulds



+ 3 decoration moulds





Kit Mr. Snow

Size: 181 h 212 mm

Item: 70.106.99.0065

Set 4 Moulds



+ 2 decoration moulds

Kit Santa

Size: 248 h 188 mm

70.104.99.0065

Set 6 Moulds



+ 4 decoration moulds





Frosty

Size: 74 x 78 h 194 mm
70.611.99.0065

Set 2 Moulds



Martino

Size: 121 x 119 h 185 mm
70.606.99.0065

Set 2 Moulds



Winter Tree

Size: Ø 108 h 210 mm
70.612.99.0065

Set 2 Moulds





Nest

Size: 116 x 116 h 150 mm

70.613.99.0065

Set 2 Moulds

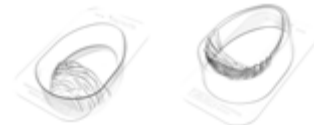

Drippy

Size: 110 x 113 h 153 mm

70.614.99.0065

Set 2 Moulds





Lady Cocca

Size: 110 x 115 h 161 mm

70.603.99.0065

Set 2 Moulds

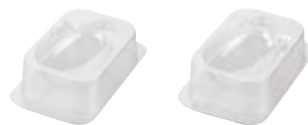

Lucky Bunny

Size: 110 x 111 h 205 mm

70.601.99.0065

Set 2 Moulds

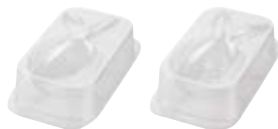



Smiling Eggs

Size: 77 x 108 h 82 mm

70.610.99.0065

Set 2 Moulds



Paul Cino

Size: 250 x 150 h 58 mm

70.602.99.0065

Set 2 Moulds



SK 3000 UOVO

Size: 140 x 100 h 50 mm

Vol: 382 ml x 2 tot.: 764 ml

70.071.99.0060



SK 4000 UOVO

Size: 220 x 160 h 80 mm

Volume: 1288 ml

70.201.99.0060





Al Fred

Size: 160 x 117 h 103 mm
70.605.99.0065

Set 2 Moulds



Loving Birds

Size: 145 x 118 h 32 mm
70.608.99.0065

Set 2 Moulds



Alfie

Size: 122 x 113 h 87 mm
70.604.99.0065

Set 2 Moulds



Secret Love

Size Big: 123 x 115 h 44 mm

Size Small: 93 x 99 h 36 mm

70.609.99.0065

Set 2 Moulds



Pumpkin

Size: Ø 138 h 103 mm

70.607.99.0065

Set 2 Moulds





Kit Effy

Size: 205 x 170 h 205 mm

70.101.99.0065

Set 5 Moulds



+ 3 decoration moulds

Kit Teddy

Size: 140 x 161 h 210 mm

70.103.99.0065

Set 5 Moulds



+ 3 decoration moulds



Koala

Size: 155 h 160 mm

70.107.99.0065

Set 4 Moulds



***Item available upon specific request, subject to minimum quantities.**

Articolo disponibile solo su ordinazione, soggetto a quantità minime.



901008 LOVE*

Size: 50 x 40 h 7 mm
70.252.00.0060



904013 CANDELE*

Size: 42 x 60 h 13 mm
70.237.00.0060



901018 ORSETTO CUORE*

Size: \varnothing 23 h 5 mm
70.218.99.0060



902020 MUSETTO CONIGLIO*

Size: 656 x 40 h 9 mm
Item: 70.220.99.0060



902025 OVETTO FANTASIA*

Size: 42 x 30 h 14 mm
70.206.99.0060



9011210 ANIMALI VARI*

Size: 48 x 29 h 8 mm
Item: 70.068.99.0060



9013026 FIORE*

Size: \varnothing 36 h 7 mm
70.089.99.0060



904010 AGRIFOGLIO*

Size: 50 x 70 h 4 mm
Item: 70.088.99.0060

EASY CHOC
SOLUZIONI PER IL CIOCCOLATO



EASYCHOC

A selection of products to create delicious homemade chocolates

Una selezione di prodotti per realizzare deliziosi cioccolatini fatti in casa.

3D CHOCO

A brand new range of silicone moulds dedicated to 3D chocolates Little chocolate treats that will surprise you with their original 3D shape!

Una nuova gamma di stampi dedicati ai cioccolatini in 3D. Piccole dolcezze al cioccolato che vi sorprenderanno per la loro forma originale e in 3D!

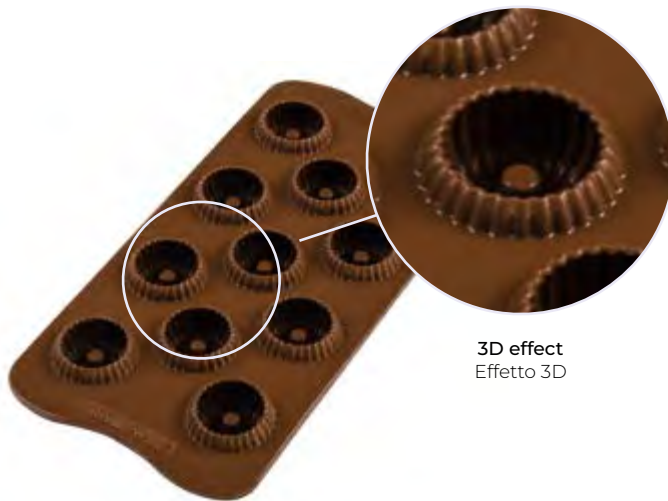

3D effect
Effetto 3D

SCG01 Monamour

Size: 30 x 22 h 25 mm
Volume: 10 ml Cavities: 15
22.101.77.0065



SCG02 Cubo

Size: 26 x 26 h 18 mm
Volume: 10 ml Cavities: 15
22.102.77.0065



SCG03 Imperial

Size: Ø 28 h 20 mm
Volume: 10 ml Cavities: 15
22.105.77.0065



SCG04 Vertigo

Size: Ø 28 h 20 mm
Volume: 10 ml Cavities: 15
22.104.77.0065



SCG05 Easter

Size: 30x43 h 16 mm
Volume 6 ml Cavities: 14
22.105.77.0065



SCG06 Christmas

Size: 34 x 34 h 18,5 mm
Volume: 4 ml Cavities: 12
22.106.77.0065



SCG07 Praline

Size: Ø 30 h 18,5 mm
Volume: 10 ml Cavities: 15
22.107.77.0065



SCG08 Fleury

Size: 30 x 30 h 15,5 mm
Volume: 9 ml Cavities: 8
22.108.77.0065



SCG09 Jack

Size: 37 x 20 h 20 mm
Volume: 8 ml Cavities: 14
22.109.77.0065



SCG10 Nature

Size: 51 x 23 h 14,5 mm
Volume: 10 ml Cavities: 8
22.110.77.0065



SCG11 Tablette

Size: 38 x 28 h 4,5 mm
Volume: 3,5 ml Cavities: 12
22.111.77.0065



SCG12 Mr. Ginger

Size: 43 x 35 h 12 mm
Volume: 4 ml Cavities: 12
22.112.77.0065



SCG13 Rose

Size: Ø 28 h 18 mm
Volume: 7 ml Cavities: 15
22.113.77.0065



SCG14 Fashion

Size: 41 x 30 h 12 mm
Volume: 8 ml Cavities: 14
22.116.77.0065



SCG15 Mood

Size: 33 x 34 h 17 mm
Volume: 8 ml Cavities: 12
22.115.77.0065



SCG16 Dino

Size: 40 x 33 h 16 mm
Volume: 8 ml Cavities: 12
22.116.77.0065



SCG17 Tea time

Size: 43,6 x 29 h 15 mm
Volume: 10 ml Cavities: 12
22.117.77.0065



SCG18 Robochoc

Size: 39 x 26 h 16 mm
Volume: 10 ml Cavities: 12
22.118.77.0065



SCG19 Fantasia

Size: Ø 28,5 h 15 mm
Volume: 8 ml Cavities: 15
22.119.77.0065



SCG20 Kono

Size: Ø 26 h 28 mm
Volume: 7,5 ml Cavities: 15
22.120.77.0065



SCG21 Macaron

Size: Ø 26 h 28 mm
Volume: 7,5 ml Cavities: 15
22.121.77.0065



SCG23 Choco Winter

Size: 33 x 27 h 15 mm
volume: 8 ml Cavities: 15
22.123.77.0065



SCG24 Choco Springlife

Size: 36 x 26 h 15 mm
volume: 8 ml Cavities: 15
22.124.77.0065



SCG25 Choco Biscuit

Size: 49 x 29 h 6,8 mm
Volume: 7 ml Cavities: 8
22.125.77.0065



SCG26 Choco Gufi

34 x 30 h 15 mm
Volume: 7,5 ml Cavities: 15
22.126.77.0065



SCG27 Choco Angels

Size: 35 x 30 h 16 mm
Volume: 9 ml Cavities: 12
22.127.77.0065



SCG28 Choco Spoon

Size: 96 x 26 h 6 mm
Volume: 43 ml Cavities: 7
22.128.77.0065



SCG29 Choco Botton

Size: 30 x 30 h 6 mm
Volume: 4,7 ml Cavities: 15
22.129.77.0065



SCG30 Choco Easter

Size: 34 x 34 h 18 mm
Volume: 9 ml Cavities: 12
22.130.77.0065



SCG31 Choco Baby

Size: 35x32 h 16 mm
Volume: 11 ml Cavities: 12
22.131.77.0065



SCG32 Choco Fruit

Size: 32 x 32 h 15 mm
Volume: 10 ml Cavities: 15
22.132.77.0065



SCG33 Choco Keys

Size: 86 x 38 h 14 mm
Volume: 10 ml Cavities: 8
22.133.77.0065



SCG34 Choco Goal

Size: Ø 27 h 13 mm
Volume: 3 ml Cavities: 18
22.134.77.0065



SCG35 Choco Pigs

Size: 31 x 29 h 15 mm
Volume 6 ml Cavities: 15
22.135.77.0065



SCG36 Classic Choco Bar

Size: 155 x 77 h 9 mm
Volume: 91 ml
22.136.77.0065



SCG37 Tablette Choco Bar

Size: 155 x 77 h 9 mm
Volume: 85 ml
22.137.77.0065



SCG38 Love Choco Bar

Size: 155 x 77 h 9 mm
Volume: 85 ml
22.138.77.0065



SCG40 Choco Frozen

Size: Ø 35 h 4 mm
Volume: 3 ml Cavities: 14
22.140.77.0065



SCG42 Starfish

Size: 34x34 h 15 mm
Volume: 5.6 ml Cavities: 14
22.142.77.0065



SCG43 Choco Melody

Size: Ø 36 h 24 mm
Volume: 5 ml Cavities: 14
22.143.77.0065



SCG45 Winter Stars

Size: Ø 30 h 15 mm
Volume: 5.6 ml Cavities: 15
22.145.77.0065



SCG46 Choco Pine

Size: 56 x 75 h 8 mm
Volume: 13 ml Cavities: 4
22.146.77.0065



SCG47 Choco Flame

Size: Ø 27 h 28 mm
Volume: 8 ml Cavities: 15
22.147.77.0065



3D effect

SCG48 My Love

Size: 31 x 30 h 15 mm
Volume: 8 ml Cavities: 12
22.148.77.0065



3D effect

SCG49 Choco Crown

Size: Ø 30 h 15 mm
Volume: 9 ml Cavities: 11
22.149.77.0065



3D effect

SCG50 Tartufino

Size: Ø 25 h 22 mm
Volume: 8 ml Cavities: 15
22.150.77.0065



3D effect

SCG51 Choco Game

Size: 22,5 x 22,5 h 20 mm
Volume: 8 ml Cavities: 15
22.151.77.0165



3D effect

SCG52 Choco Spiral

Size: Ø 24 h 30 mm
Volume: 9 ml Cavities: 15
22.152.77.0165



3D effect

SCG53 Choco Drop

Size: Ø 23 h 30 mm
Volume: 8 ml Cavities: 15
22.153.77.0065



3D effect

SCG54 Choco Trees

Size: Ø 28 h 30 mm
Volume: 8,5 ml Cavities: 15
22.154.77.0065

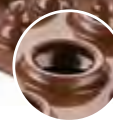

3D effect

SCG055 Amleto

Size: 29 x 32 h 21 mm
Volume: 10 ml Cavities: 12
22.155.77.0065



3D effect

SCG056 Mr & Mrs Brown

Size: Ø 25 h 40,5 mm
Volume: 10 ml Cavities: 15
22.156.77.0065



3D effect

SCG57 Kiss

Size: Ø 28,3 h 23,7 mm
Volume: 8,5 ml Cavities: 12
22.157.77.0065



3D effect

SCG058 Choco egg

Size: Ø 23 h 30 mm
Volume: 8 ml Cavities: 15
22.158.77.0065



3D effect

SCG059 Choco Friture

Size: 43 x 38 mm
Volume: 5 ml Cavities: 12
22.159.77.0065



3D effect

SCG60 Winter ball

Size: Ø 27 h 25 mm
Volume: 8 ml Cavities: 14
22.160.77.0065



3D effect

SCG061 Choco Delica

Size: Ø 32 h 25 mm
Volume: 11,5 ml Cavities: 11
22.161.77.0265



3D effect

SCG062 Snowman

Size: Ø 26 h 35 mm
Volume: 10 ml Cavities: 14
22.162.77.0265



3D effect

SCG063 Choco Flower

Size: Ø 38 h 12 mm
Volume: 9 ml Cavities: 8
22.163.77.0265



3D effect

SCG064 Choco Uovo

Size: 103 x 79 h 10 mm
Volume: 50 ml Cavities: 2
22.164.77.0265



SCG066 Dubai Bar

Size: 155 x 75 h 15.5 mm

Volume: 175 ml

22.166.77.0265



SCG065 Choco Schiaccianoci

Size: 26 x 84 h 14 mm

Volume: 13.5 ml Cavities: 6

22.165.77.0265



SF125 Chocogianduia

Size: 50 x 18 h 23 mm
Volume: 14 ml Cavities: 24
26.125.77.0065



SF129 Mini Büche

Size: 44 x 18 h 20 mm
Volume: 14 ml Cavities: 30
26.129.77.0065



SF142 My Chocolate Spoon

Size: 120 x 35 h 12 mm
Volume: 19 ml Cavities: 8
26.142.77.0065



SF151 Choco Flash

Size: Ø 52 h 5 mm
Volume: 8 ml Cavities: 11
26.151.77.0065



SF169 Choco Abc

Volume: 1,5 ml Cavities: 81
Tot.: 103,5 ml
26.169.77.0065



SF174 Choco 123

Volume: 2 ml Cavities: 60
Tot.: 120 ml
26.174.77.0065



SF184 My Snack

Size: 100 x 26 h 16 mm
Volume: 40 ml Cavities: 8
26.184.77.0065



SF196 CHOCO TAGS IN LOVE

Size: 60 x 39 h8mm
Volume: 9 ml Cavities: 16
26.196.77.0065



SF198 Winter Choco Tags*

Size: 37 x 60 h 8 mm
Volume: 9 ml Cavities: 16
26.198.77.0065



***Item available upon specific request, subject to minimum quantities.**
Articolo disponibile solo su ordinazione, soggetto a quantità minime.

SF199 Funny Owls Choco Tags

Size: 62 x 40 h 8 mm
Volume: 10 ml Cavities: 12
26.199.77.0065



SF213 Choco Block

Size: 90 x 45 h 28 mm
Volume: 75 ml Cavities: 10
26.213.77.0065



PF214 Puppy Choco Tag

Size: Ø 55 h 8mm
Volume: 13 ml Cavities: 11
26.214.77.0065



CKC04 Cookie Gnam Gnam Slim

Size: 47 x 57 h 5 mm
Volume: 5,5 ml Cavities: 6
22.164.77.0165



CKC05 Cookie Dolce Vita Slim

Size: Ø 57 h 5 mm
Volume: 5,6 ml Cavities: 6
22.165.77.0165



CKC06 Cookie Love Slim

Size: 64 x 63 h 5 mm
Volume: 8,6 ml Cavities: 6
22.166.77.0165



CKC14 Easter Slim

Size: Ø 57 h 5 mm
Volume: 5,6 ml Cavities: 6
22.174.77.0165



CKC01 Snowman Slim

Size: 47 x 57 h 5 mm
Volume: 5,5 ml Cavities: 6
22.161.77.0165



CKC02 Cookie Xmas Slim

Size: Ø 57 h 5 mm
Volume: 5,6 ml Cavities: 6
22.162.77.0165



CELEBRATION

CELEBRAZIONI



CA01 Creative Xmas Countdown

Size Box: 22 x 30 h 19 mm

Size Chocolates: 28 x 28 h 13 mm

Volume: 5 ml Cavities: 25

25.741.63.0060

Set: 1 Gift Box + 1 Platinum Silicone Mould



Front / Fronte

Back / Retro

SFT731 Plume Cake Rose

Size: Size: Ø 70 h 41 mm
Volume: 2,5 L
20.731.03.0063



Diva*

Size: 130 x 74 h 28 mm
Volume: 180 ml Cavities: 4
26.266.13.0065



***Item available upon specific request, subject to minimum quantities.**
Articolo disponibile solo su ordinazione, soggetto a quantità minime.

HSF01 Happy Xmas

Size: Ø 74 h 34 mm
Volume: 68 ml Cavities: 4
26.001.01.0065



HSF02 Happy Love

Size: 60 x 62 mm
Volume: 70 ml Cavities: 4
26.002.01.0065



HSF06 Happy Toys

Size: 77 x 57 h 28 mm
Volume: 106 ml Cavities: 4
26.006.61.0065



HSF08 Happy Sea

Size: 42 x 86 mm
Volume: 62 ml Cavities: 4
26.008.93.0065



SFT203 Christmas Tree

Size: 280 x 200 h 40 mm
Volume: 1000 ml
20.203.63.0065



SFT201 Etoile

Size: Ø 260 h 40 mm
Volume: 1200 ml
20.201.63.0063



SFT181 Charlotte

Size: Ø180 h 60 mm
Volume: 1,3 l
20.181.63.0065



SFT327 Croissant

Size: 235 x 170 h 60 mm
Volume: 1,2 l
20.327.76.0063



SF194 Flower

Size: Ø 63,5 h 31,7 mm
Volume: 80 ml Cavities: 11
26.194.19.0063



SFT317 Narcissus

Size: Ø 180 h 80 mm
Volume: 1,3 l
24.317.19.0063



SF135 Mini Springlife*

Size: Ø 43 h 20 mm
Volume: 20 ml Cavities: 15
26.135.85.0065



SF118 Tulip*

Size: 76 x 50 h 29 mm
Volume: 62 ml Cavities: 8
26.118.05.0063



***Item available upon specific request, subject to minimum quantities.**
Articolo disponibile solo su ordinazione, soggetto a quantità minime.

ACCESSORIES

ACCESSORI

Everything that makes a difference and simplifies everyday work. Reliable, durable and effective tools for consistently uniform results. A range that spans from tools for even baking to precision decoration, allowing you to choose quality that supports creativity.

Tutto ciò che fa la differenza e semplifica il lavoro di tutti i giorni. Strumenti affidabili, durevoli ed efficaci, per risultati sempre uniformi. Un'offerta che spazia dagli strumenti per la cottura omogenea alla decorazione di precisione, per scegliere la qualità che sostiene la creatività.



Funnel Choc

Size: Ø 130 h 140 mm
Volume: 1000 ml + 3 tubes
70.095.99.0065

 **BPA
FREE**
**PFAS
FREE**



Ø 10



Ø 7



Ø 4

In dotazione 3 puntali intercambiabili in silicone

Interchangeable silicone nozzle

Funnel Choc by Silikomart is a professional quality dosing funnel, excellent to prepare your desserts. Perfect to fill the moulds by pouring the right quantity of product, to decorate and garnish with the utmost precision and without waste. Suitable for liquids, fondants, jellies, chocolate, creams, etc.

Il Funnel Choc di Silikomart è un colino dosatore, di qualità professionale, eccellente per la preparazione delle vostre portate. Perfetto per riempire gli stampi versando la giusta dose di prodotto, per decorare e guarnire con estrema precisione e senza spreco. Adatto per liquidi, fondenti, gelatine, cioccolato, creme, etc.



Decorative Pen

Size: 88x54 h 46 mm
Volume: 55-60 ml
72.342.86.0069



The decorative pen is practical for the decorations of cakes with liquid chocolate, creams and liquid mixtures. It is composed by a silicone body, four decorative lips and a cap, suitable to realize the most precise details. The body can be removed and washed separately with the other components in the dishwasher. It is a product made with a high quality silicone, 100% Made in Italy, and with a resistant quality of plastic.

Penna decorativa, pratica per decorare dolci con cioccolato fuso, crema e preparazioni liquide. Dotata di un corpo in silicone, quattro beccucci decorativi ed un tappo, adatti a realizzare i dettagli più minuziosi. E' possibile smontare il corpo della penna e lavare il tutto in lavastoviglie. Prodotto in silicone di alta qualità 100% Made in Italy e plastica resistente.

Spoon Decor

Set 2 spoons | **70.131.99.0067**
Set 2 spoons + cup | **70.131.98.0067**
Cup | **70.140.99.0067**



23 cm

19 cm

Choco Leaves Spatula

01 Size: 80 x 25 mm
73.511.99.0062

02 Size: 120 x 25 mm
73.512.99.0062



Choco Leaves Spatula

03 Size: 50 x 35 mm
73.513.99.0062

04 Size: 60 x 45 mm
73.514.99.0062



Choco Leaves Spatula

05 Size: 40 x 20 mm
73.515.99.0062

06 Size: 60 x 30 mm
73.516.99.0062

07 Size: 80 x 40 mm
73.517.99.0062



2 Prongs Fork / Forchetta 2 Rebbi

70.174.99.0001



3 Prongs Fork / Forchetta 3 Rebbi

70.175.99.0001



Spiral Fork / Forchetta a spirale

70.173.99.0001



Fork to grab and dip the chocolates into the topping / Forchetta per afferrare e intingere i cioccolatini nella copertura

Scraper 170 mm

Size: 170 h 60 mm
70.171.99.0001



Scraper 270 mm

Size: 270 h 55 mm
70.172.99.0001



Stainless steel scrapers with plastic handle. / Raschietti in acciaio inossidabile con manico in plastica.

Edge Spatulas / Spatole Angolari

Edge stainless steel spatula with plastic handle. / *Spatola angolare in acciaio inossidabile con manico in plastica.*



	SP-ANG 20	SP-ANG 33	SP-ANG 38	SP-ANG 37
Size	9 cm	16 cm	20 cm	25 cm
Item	73.438.99.0001	73.436.99.0001	73.435.99.0001	73.430.99.0001

Straight spatulas

Stainless steel spatula with plastic handle. / *Spatola liscia in acciaio inox con manico in plastica.*

SP 20

Size: 11 cm
73.431.99.0001

SP 38

Size: 25,5 cm
73.434.99.0001

SP 43

Size: 31 cm
73.437.99.0001

SP 28

Size: 15,5 cm
73.432.99.0001

SP 33

Size: 20,5 cm
73.433.99.0001

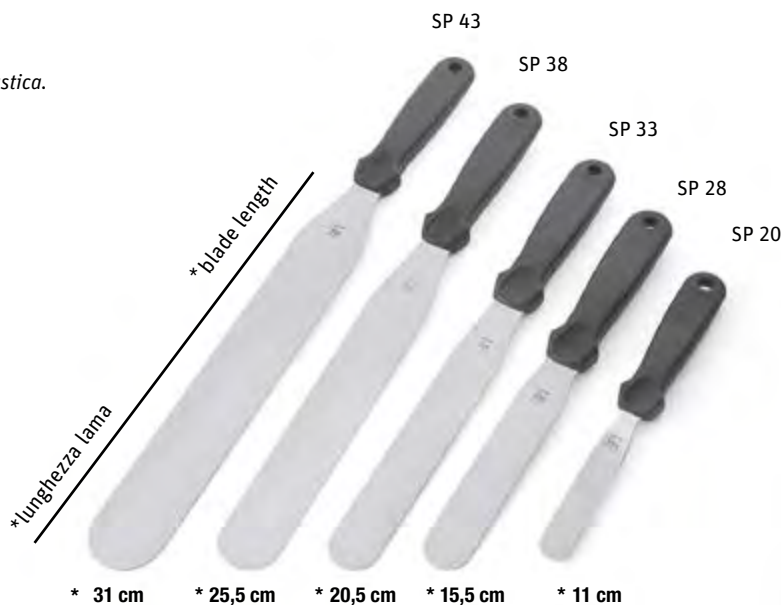

SP Special 20

Spatola angolare a punta in acciaio inox con manico in plastica. / *Pointed stainless steel edge spatula with plastic handle.*

Blade length: 8 cm
73.439.99.0001



SP 10 - Straight spatulas

Spatola a punta in acciaio inox con manico in plastica. / *Pointed stainless steel spatula with plastic handle.*

Blade length: 10 cm
73.440.99.0001



Spatola in acciaio / Steel spatula

Stainless steel spatula excellent for stretching out and smoothing chocolate, creamy and liquid mixture. /

Spatola in acciaio inossidabile eccellente per stendere e lisciare cioccolato, creme e miscele liquide.

Size: 120 h 120 mm

70.141.00.0001



Raschietti / Scrapers

Stainless steel scrapers with plastic handle. /

Raschietti in acciaio inossidabile con manico in plastica.

SCRAPER 130 mm

Size: 130 h 15 mm

70.157.99.0001

SCRAPER 175 mm

Size: 175 h 12 mm

70.158.99.0001



Tarocco / Dough Scraper

Plastic dough scrapers / *Raschietti in plastica.*

Size: 145 x 97 h 2 mm

Set: 10 pcs

70.184.20.0001



Roller Dockers

Size: 120 mm

70.037.00.0001



Cutting Rollers

Size: 120 mm

70.036.00.0001



Graters

- Stainless steel graters with plastic ergonomic handles available in two different sizes to suit any ingredient, including chocolate and citrus zest.
- Safety snap on cover
- *Grattugie in acciaio inox con manico ergonomico in plastica disponibili in due diverse ampiezze per adattarsi a qualsiasi ingrediente, inclusi cioccolato e scorze di agrumi.*
- *Copertura di sicurezza a scatto*

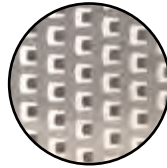
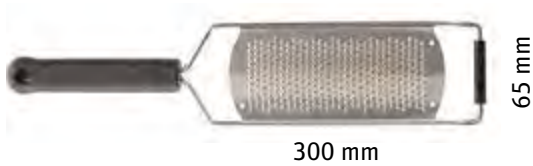

Grater 1 - Fine Edge

Size: 65 x 130 mm
73.550.99.0001

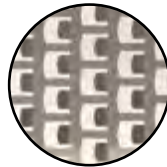
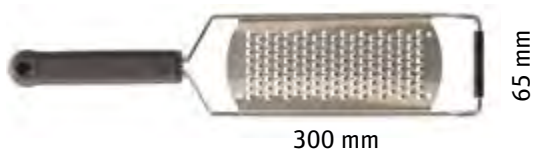

Grater 3 - Medium Edge

Size: 65 x 130 mm
73.552.99.0001



Grater 5 - Medium Edge

Size: 65 x 130 mm
73.554.99.0001

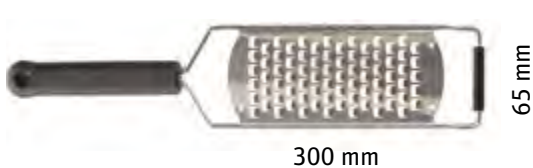

Grater 7 - Coarse Edge

Size: 65 x 130 mm
73.556.99.0001

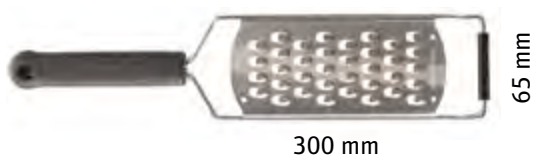

Grater 9 - Coarse Edge

Size: 65 x 130 mm
73.558.99.0001

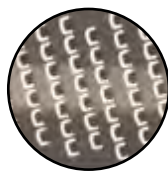

Grater 2 - Fine Edge Narrow

Size: 35 x 230 mm
73.551.99.0001



Grater 4 - Medium Edge Narrow

Size: 35 x 230 mm
73.553.99.0001



Grater 6 - Medium Edge Narrow

Size: 35 x 230 mm
73.555.99.0001



Grater 8 - Coarse Edge Narrow

Size: 35 x 230 mm
73.557.99.0001



Grater 10 - Coarse Edge Narrow

Size: 35 x 230 mm
73.559.99.0001

Bent steel tong

Professional kitchen tongs, featuring an ergonomic elbow design that makes them suitable even for the most delicate decorations and foods. The practical and comfortable handle of these professional tongs with non-slip grip ensures a secure, precise and firm grip. Made of stainless steel, they are dishwasher safe. / *Pinza professionale da cucina, caratterizzata dal design ergonomico a gomito che la rende adatta anche a decori e cibi più delicati. La pratica e comoda impugnatura della pinzetta professionale con grip antiscivolo, garantisce una presa sicura, precisa e ferma. Realizzata in acciaio inox, è lavabile in lavastoviglie.*



Bent steel tong 16 cm

Pinza piegata in acciaio 16 cm
73.520.99.0001



Straight steel tong 30 cm

Pinza dritta in acciaio 30 cm
73.521.99.0001



Bent-tip steel tong 20 cm

Pinza con punta piegata in acciaio 20 cm
73.522.99.0001

Steel Croissant Cutting Roller

Croissant cutter ideal for speeding up the cutting of puff pastry and other preparations into triangles of different sizes.
Taglia croissant ideale per velocizzare il taglio della pasta sfoglia e di altre preparazioni in triangoli di diverse dimensioni.

Item	73.530.99.0001	73.531.99.0001
Misure	7x10 cm	12x21 cm



Item	73.532.99.0001	73.533.99.0001	73.534.99.0001
Misure	12x15 cm	18x14 cm	18x20 cm



Double Steel Croissant Cutting Roller 18x20 cm. /
Doppio rullo taglia croissant in acciaio 18x20 cm
73.535.99.0001



Modelling Tools 8

Set 8 pcs
72.338.19.0096



Roll Tool

72.341.19.0096



Smooth Rolling Pin

Big Size: \varnothing 40 x 400 mm
70.306.87.0069

Small Size: \varnothing 25 x 230 mm
70.305.87.0069



Adjustable Rolling Pins

Size: \varnothing 40 x 400 mm
6 Rings: 2x1 mm
2x2 mm 2x3 mm
70.300.20.0065



Decorative Rollin Pins

Bricks Size: \varnothing 42 x 400 mm
70.301.20.0065



Heart Size: \varnothing 42 x 400 mm
70.303.20.0065



Stripes Size: \varnothing 42 x 400 mm
70.302.20.0065



Star Size: \varnothing 42 x 400 mm
70.304.20.0065



Whisk / Frusta

- Black thermoplastic handle
- Wires made of stainless steel
- Waterproof handle
- With suspension eye
- Heavy quality
- *Impugnatura in materiale termoplastico nero*
- *Fili in acciaio inossidabile*
- *Impugnatura impermeabile*
- *Con occhiello di sospensione*
- *Qualità pesante*

Wire thickness / spessore filo 2,2 mm

Steel Whisk
Size: 25 - Ø 60 mm
73.540.99.0001

Steel Whisk
Size: 40 - Ø 76 mm
73.543.99.0001

Steel Whisk
Size: 30 - Ø 70 mm
73.541.99.0001

Steel Whisk
Size: 45 - Ø 80 mm
73.544.99.0001

Steel Whisk
Size: 35 - Ø 72 mm
73.542.99.0001



Whisk small
Mini Size: 210 - Ø 50 mm
73.446.99.0001



Whisk medium
Medium Size: 245 - Ø 60 mm
73.447.99.0001



Whisk big
Medium Size: 300 - Ø 70 mm
73.448.99.0001



Spoon spatula / Spatola a cucchiaino

Polyamide and fiberglass spoons resistant to high temperatures and dishwasher safe for thorough hygiene.

Cucchiaini in poliammide e fibra di vetro resistenti alle alte temperature e lavabili in lavastoviglie per un'igiene profonda.

Size: 30 cm
73.560.87.0001

Size: 40 mm
73.562.87.0001

Resistant up to 260°C /
Resiste fino a 260°C



Size: 35 mm
73.561.87.0001

Size: 50 mm
73.563.87.0001



ACC 022 Pennello Piccolo





Size: 180 mm

-  70.048.10.0001
-  70.048.60.0001
-  70.048.72.0001



ACC 023 Pennello Medio



Size: 210 mm

-  70.049.10.0001
-  70.049.60.0001
-  70.049.72.0001
-  70.049.48.0001



ACC 024 Pennello Barbeque





Size: 370 mm

-  70.050.10.0001
-  70.050.60.0001
-  70.050.72.0001



ACC 026 Spatola Piccola





Size: 245 mm

-  70.052.10.0001
-  70.052.17.0001
-  70.052.48.0001
-  70.052.60.0001
-  70.052.87.0001



ACC 027 Spatola Grande





Size: 260 mm

-  70.053.10.0001
-  70.053.17.0001
-  70.053.48.0001
-  70.053.60.0001
-  70.053.87.0001



ACC 028 Cucchiaino Spatola





255mm

-  70.054.10.0001
-  70.054.17.0001
-  70.054.48.0001
-  70.054.60.0001
-  70.054.87.0001



ACC 029 Spatole SET 3 PCS

245 - 260 - 255 mm

-  70.055.10.0001
-  70.055.17.0001
-  70.055.48.0001
-  70.055.60.0001
-  70.055.87.0001



Silicone Spoon SPC

Size: 25 cm
70.104.87.0002

Size: 36 cm
70.105.87.0002

Size: 41 cm
70.106.87.0002

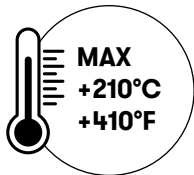

Silicone Spatula SPS

Size: 25 cm
70.101.87.0002

Size: 36 cm
70.102.87.0002

Size: 41 cm
70.103.87.0002

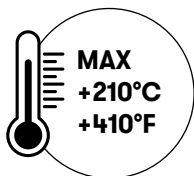

ACC 071 Miss Hot

Size: 175 x 175 mm



ACC 084 Pot Holder

Size: 250 x 250 x 5 mm

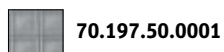

ACC 074 Pot Holder

Size: 175 x 175 mm

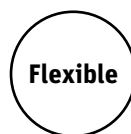
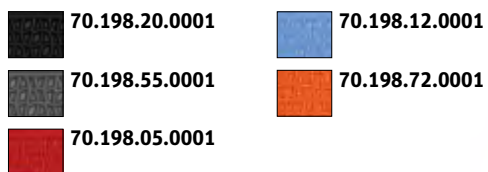

Zeus Profi Glove

Size: 385 x 168 h 20 mm

 70.500.20.0001

 70.500.55.0001



Zeus Glove

Size: 285 x 168 h 20 mm

 70.200.20.0001

 70.200.05.0001

 70.200.55.0001

 70.200.12.0001

 70.200.72.0001*

*Item available upon specific request, subject to minimum quantities.
Articolo disponibile solo su ordinazione, soggetto a quantità minime.





ACC 073 Mister Hot

Size: 274 x 167 mm

 70.400.20.0001

 70.400.12.0001

 70.400.55.0001

 70.400.62.0001

 70.400.05.0001



Grippy

Silicone mitt / Presina in silicone

Size: 128 x 120 h 66 mm
70.202.55.0001



Available display
Disponibile display
Pcs/Display: 10



Set Laccio 55

Size: 550 mm
25.411.24.0062

Set 3 Pcs



Set Laccio 25

Size: 250 mm
25.410.62.0096

Set 6 Pcs



CRSP01 Crispy Mat - Big

Size: 410 x 295 h 11 mm
23.025.85.0065

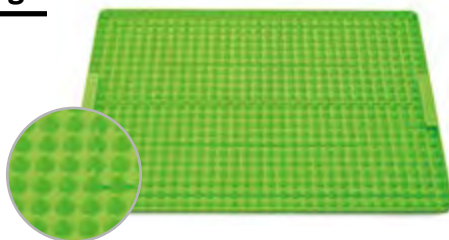

Kitchen Pad

Size: 120 x 195 h 11 mm
23.028.72.0062



CUP01 - Set 6 Pirottini

Size: Ø 68 h 32 mm
25.420.01.0165



PAN01 Happy Snack Square

Size: 40 x 40 h10mm
12.221.85.0000



Free Bake

Size: 1070 x 55 h 95 mm
25.982.85.0065

Silicone Band with magnets /
Fascia in silicone con magneti



COC 02 Cocotte

Size: Ø 125 h 50 mm
Vol: 400 ml

 24.002.86.0065 transp.



COC 03 Cocotte

Size: Ø 185 h 65 mm
Vol: 1200 ml

 24.003.86.0065 transp.

 24.003.97.0065





COC 04 Cocotte

Size: Ø 235 h 75 mm
Vol: 2200 ml

 24.004.86.0065 transp.

 24.004.98.0065

 24.004.52.0065

 24.004.97.0065



CAPFLEX RANGE

Elastic and washable in dishwasher, CAPFLEX is the eco-friendly alternative to the plastic wrap. Made of food safe silicone, it is available in 4 diameters: 40mm/1,57", 55mm/2,16", 80mm/3,14" and 105mm/4,13". This functional transparent silicone lid is perfect to vacuum-seal bowls and containers and preserve freshness and taste of your foods.

Elastico e lavabile in lavastoviglie, CAPFLEX è l'alternativa eco-friendly alla pellicola trasparente. Realizzato e disponibile nei diametri 40, 55, 80 e 105mm, questo pratico coperchio trasparente è ideale per conservare sottovuoto scodelle e contenitori e per preservare la freschezza e il sapore dei vostri cibi e bevande.

Capflex S

Size: Ø 40 mm
Set 3 Pcs

 25.028.90.0061

 25.028.91.0061





← Ø25/45mm →



Capflex M

Size: Ø 55 mm
Set 2 Pcs

 25.029.90.0061

 25.029.91.0061



← Ø45/65mm →



Capflex L

Size: Ø 80 mm

 70.166.90.0061

 70.166.91.0061



← Ø65/90mm →





Capflex XL

Size: Ø 105 mm

 70.165.90.0061

 70.165.91.0061

 70.165.73.0061

 70.165.89.0061





← Ø90/130mm →



Capflex XXL

Size: Ø 160 mm

 70.169.90.0061

 70.169.91.0061

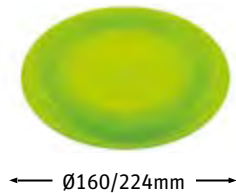

Capflex Set

Size: Ø 40 mm (S), Ø 55 mm (M), Ø 80 mm (L),
Ø 105 mm (XL), Ø 160 mm (XXL)

25.165.90.0065



Ø 40 mm - CAPFLEX S
From 25 to 45 mm



Ø 55 mm - CAPFLEX M
from 45 to 65 mm



Ø 80 mm - CAPFLEX L
from 65 to 90 mm



Ø 105 mm - CAPFLEX XL
from 90 to 130 mm



Ø 160 mm - CAPFLEX XXL
from 160 to 224 mm



CFF 09B Coverflex

Size: \varnothing 90 mm
70.090.86.0696

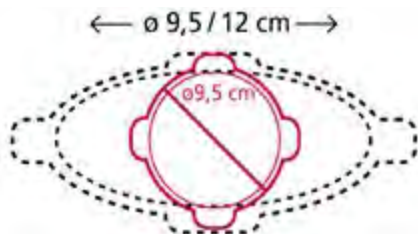

CFF 11B Coverflex

Size: \varnothing 110 mm
70.110.86.0696

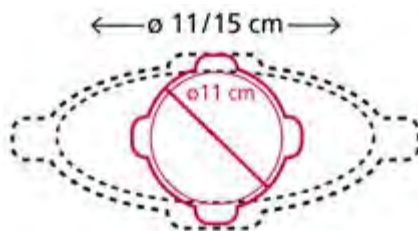

CFF 16B Coverflex

Size: \varnothing 160 mm
70.160.86.0696

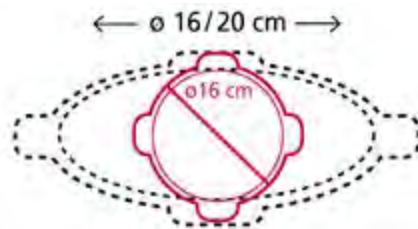

CFF 21B Coverflex

Size: \varnothing 210 mm
70.210.86.0696

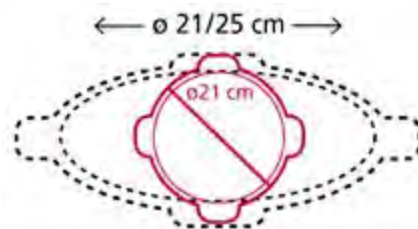

CFF SET3B Coverflex

Size: \varnothing 110-160-210 mm
Set 3 Pcs
25.014.86.0096

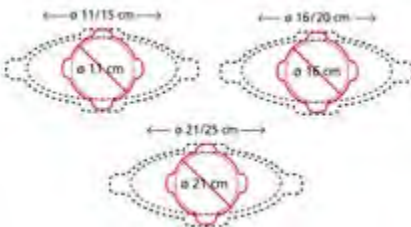

CFF SET4B Coverflex

Size: \varnothing 90-110-160-210 mm
Set 4 Pcs
25.015.86.0096

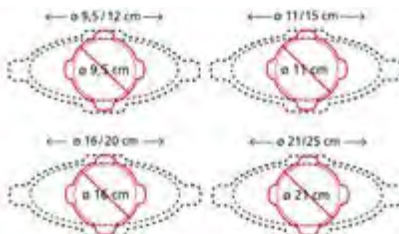

UFO RANGE

Store foods properly is very important, which is why Silikomart has conceived UFO: a colorful range of universal silicone lids, perfect to cover and to vacuum-seal your foods.

Conservare in modo appropriato gli alimenti è importantissimo, ecco perchè Silikomart ha concepito UFO: una coloratissima gamma di coperchi universali, perfetti per coprire e per conservare sottovuoto i vostri alimenti.



UFO 10

Size: Ø 105 mm

 72.100.86.0062 transp.



UFO 15

Size: Ø 155 mm

 72.150.86.0062 transp.



UFO 21

Size: Ø 215 mm

 72.210.81.0062

 72.210.86.0062 transp.



UFO 25

Size: Ø 255 mm

 72.250.86.0062 transp.



UFO 29

Size: Ø 295 mm

 72.290.86.0062 transp.



UFO 34

Size: Ø 340 mm

 72.340.86.0062 transp.

 72.340.87.0062



Vapo Twist - s

Size: Ø 220 mm

VAPO TWIST IS COMPOSED BY:

- 1 silicone cover Ø 8.66"
- 1 polycarbonate removable top

VAPO TWIST È COMPOSTO DA:

- 1 coperchio Ø 220 mm
- 1 tappo rimovibile in policarbonato

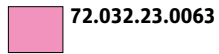

72.032.23.0063

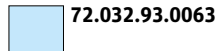

72.032.93.0063

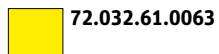

72.032.61.0063

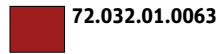

72.032.01.0063

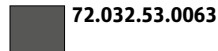

72.032.53.0063

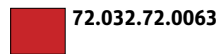

72.032.72.0063

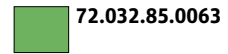

72.032.85.0063



- Avoids dispersion of heat
- Avoids the discharge of lather
- Flexible over time
- Steam cooking
- Ecologic
- Suitable for high temperatures

- Evita la dispersione di calore
- Evita la fuoriuscita della schiuma
- Flessibile nel tempo
- Cucina al vapore
- Ecologico
- Adatto alle alte temperature

How to use: / Utilizzo:



With polycarbonate top
Con tappo in policarbonato



With the polycarbonate top twisted
Con tappo scostato



Without the polycarbonate top
Senza tappo

Vapo

Size: Ø 300 mm

Food grade silicone cover provided with special splits to allow the discharge of the steam during the cooking phase. It is also useful to avoid the discharge of lather during the boiling of water.

Coperchio, dotato di apposite fessure per permettere la fuoriuscita del vapore in fase di cottura. Utile anche per evitare la fuoriuscita della schiuma durante l'ebollizione.

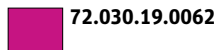

72.030.19.0062

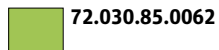

72.030.85.0062

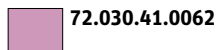

72.030.41.0062



Round Cooling Grid

Round Size: 300 mm
73.442.99.0001



Wonder cooling grid

Size: 400 x 600 mm
43.447.99.0000

Size: 300 x 300 mm
43.449.99.0000

Size: 500 x 500 mm
43.448.99.0000



Cake Cutter

Size: 300 mm
73.441.99.0001



Thermo Choc

Size: 320 x 70 mm
70.096.98.0062

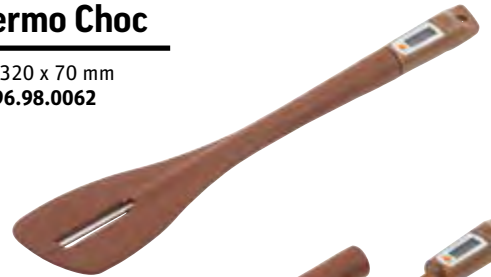

Blowthorch

Volume: 20 ml
70.056.99.0001



Volume: 60 ml
70.058.99.0001

Gradual Bottles



Volume: 250 ml
70.137.99.0061

Volume: 500 ml
70.138.99.0061

Stainless Cake Tray

Size: 280 x 330 mm
70.132.00.0001



Roll / Rotolo PVC

Size: 200 m x 25 mm
73.471.86.0101

Size: 200 m x 45 mm
73.475.86.0101

Size: 200 m x 30 mm
73.472.86.0101

Size: 200 m x 50 mm
73.476.86.0101

Size: 200 m x 35 mm
73.473.86.0101

Size: 200 m x 55 mm
73.477.86.0101

Size: 200 m x 40 mm
73.474.86.0101

Size: 200 m x 60 mm
73.478.86.0101

Size: 10 m x 60 mm
73.498.86.0001

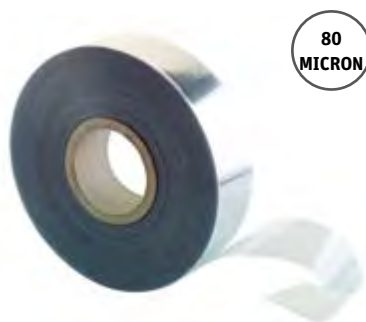

Fogli / Sheets PVC

Size: 60 x 40 cm
50 sheets / fogli
73.479.86.0001



Guitar sheets / Fogli chitarra

Flexible guitar sheets to get a shiny effect on your chocolates. /
Fogli flessibili per ottenere un effetto lucido sui tuoi cioccolatini.

Size: 600 x 400 mm
50 sheets / fogli
73.480.86.0001



Carta forno / Baking paper*

Size: 600 x 400 mm - 500 sheets / fogli
73.481.99.0001

Size: 600 x 400 - 1000 sheets / fogli
73.482.99.0001



*Item available upon specific request, subject to minimum quantities.
Articolo disponibile solo su ordinazione, soggetto a quantità minime.

Cake Cardboard Drums Round

Size: Ø 20 cm
Black: **73.451.97.0001***

Size: Ø 25 cm
Silver: **73.452.99.0001**
Gold: **73.452.98.0001**
Black: **73.452.97.0001**



Size: Ø 30 cm
Silver: **73.453.99.0001**
Gold: **73.453.98.0001**
Black: **73.453.97.0001**

Size: Ø 35 cm
Silver: **73.454.99.0001**
Gold: **73.454.98.0001**
Black: **73.454.97.0001**



Size: Ø 40 cm
Silver: **73.455.99.0001**
Gold: **73.455.98.0001**
Black: **73.454.97.0001**



Size: Ø 45 cm
Silver: **73.456.99.0001**
Gold: **73.456.98.0001**
Black: **73.456.97.0001**

Cake Cardboard Drums Square

Size: 20 x 20 cm
Silver: **73.461.99.0001***
Black: **73.461.97.0001***



Size: 25 x 25 cm
Silver: **73.462.99.0001**
Gold: **73.462.98.0001**
Black: **73.462.97.0001**



Size: 30 x 30 cm
Silver: **73.463.99.0001**
Gold: **73.463.98.0001**
Black: **73.463.97.0001**

Size: 35 x 35 cm
Silver: **73.464.99.0001**
Gold: **73.464.98.0001**
Black: **73.464.97.0001**



Size: 40 x 40 cm
Silver: **73.465.99.0001**
Gold: **73.465.98.0001**
Black: **73.465.97.0001**

Size: 45 x 45 cm
Silver: **73.466.99.0001**
Gold: **73.466.98.0001**
Black: **73.466.97.0001**

**Item available upon specific request, subject to minimum quantities. / Articolo disponibile solo su ordinazione, soggetto a quantità minime.*



Cookie cutters sets to make cookies and sugar paste or chocolate paste decorations; each set allows you to create nice shapes for decorating cup cakes, cookies and cupcakes.

Set di tagliapasta per realizzare biscottini e decorazioni utilizzando pasta di zucchero e cioccolato plastico. Ogni set permette di ottenere simpatiche figure per decorare cup cake, biscottini e torte a tuo piacimento.



Cutter 03 Irregular Square

Size: 3 x 3 - 4 x 4 - 5 x 5 - 6 x 6 - 7 x 7
8 x 8 - 9 x 9 - 10 x 10 - 11 x 11 cm
72.303.87.0069



Cutter 05 Irregular Hexagon

Size: 3 x 2.5 - 4 x 3.5 - 5 x 4.5 - 6 x 5.5 - 7.5 x 6.5
8.5 x 7.5 - 9.5 x 8.5 - 10.5 x 9 - 12 x 10 cm
72.305.87.0069

Cutter 06 Regular Hexagon

Size: 3 x 2.5 - 4 x 3.5 - 5 x 4.5 - 6 x 5.5 - 7.5 x 6.5
8.5 x 7.5 - 9.5 x 8.5 - 10.5 x 9 - 12 x 10 cm
72.306.87.0069



Cutter 07 Irregular Oval

Size: 3 x 4.3 - 3.9 x 5.7 - 5 x 7 - 5.9 x 8.3
6.9 x 9.6 - 7.8 x 11 - 8.8 x 12.3 cm
72.307.87.0069



Cutter 09 Irregular Clover

Size: Ø 2.9 - 4.1 - 5.4 - 6.8 - 8.3 - 9.3
10.8 - 12.4 cm
72.309.87.0069

Cutter 10 Regular Clover

Size: Ø 2.9 - 4.1 - 5.4 - 6.8 - 8.3 - 9.3
10.8 - 12.4 cm
72.310.87.0069



Cutter 15 Irregular Moon

Size: 8 x 3.5 - 9 x 4.5 - 9.5 x 6 - 10 x 7
11.5 x 8 - 12 x 9.5 - 13 x 10.5 cm
72.315.87.0069

Cutter 16 Regular Moon

Size: 8 x 3.5 - 9 x 4.5 - 9.5 x 6 - 10 x 7
11.5 x 8 - 12 x 9.5 - 13 x 10.5 cm
72.316.87.0069



Cutter 17 Irregular Flower

Size: Ø 3.5 - 4.5 - 6 - 7 - 8 - 9.5 - 10.5 - 12 cm
72.317.87.0069

Cutter 18 Regular Flower

Size: Ø 3.5 - 4.5 - 6 - 7 - 8 - 9.5 - 10.5 - 12 cm
72.318.87.0069

Cutter 19 Irregular Boat

Size: 3 x 2 - 4.5 x 3 - 6 x 3.5 - 7.5 x 4.5
9 x 5.5 10.5 x 6.5 - 12 x 7.5 cm
72.319.87.0069



Cutter 12 David Star

Size: Ø 4 - 5.5 - 7 - 8.5 - 10 - 11.5 - 13 cm
72.312.87.0069



Cutter 11 Star

Size: Ø 4 - 5.5 - 7 - 8.5 - 10 - 11.5 - 13 cm
72.311.87.0069



Acc079 Star

Size: 100 x 100 h 25 mm
70.100.05.0060



Acc097 Snow Man

Size: 115 x 73 h 25 mm
70.100.07.0060



ACC 077 Doppio Cuore

140 x 96 h 25 mm
70.100.03.0060



ACC 078 - ORSO

87 x 106 h 25 mm
70.100.04.0060



Adjustable Pastry Wheel Cutter

5 Blades:
43.451.99.0001 - Regular

5 Blades:
43.452.99.0001 - Irregular

7 Blades:
43.453.99.0001 - Regular

7 Blades:
43.454.99.0000 - Irregular



Piping bags Poliuretano

30 cm

Size: 200 mm

70.143.99.0066

Size: 250 mm

70.144.99.0066

Size: 300 mm

70.145.99.0066*

20 cm

25 cm



- Synthetic fabric, coated
- Food safe
- Including hanger
- Multiple uses
- Waterproof

- Tessuto sintetico, rivestito
- Adatto al contatto con gli alimenti
- Gancio incluso
- Riutilizzabile più volte
- Impermeabile

*Item available upon specific request, subject to minimum quantities.

Articolo disponibile solo su ordinazione, soggetto a quantità minime.

Disposable piping bags small

Size: 360 mm

Set: 24 pcs

70.097.99.0065

Size: 560 mm

Set: 24 pcs

70.149.99.0065



Disposable piping bags

Size: 560 mm

Set: 100 pcs

70.142.99.0065



Cotton piping bags "standard"

With upper seam and reinforced tip. / Con cucitura superiore e punta rinforzata.

41.943.99.0000	STD	025	25 cm
41.944.99.0000	STD	028	28 cm
40.871.00.0000	STD	034	34 cm
40.856.00.0000	STD	040	40 cm
40.891.00.0000	STD	046	46 cm
41.598.99.0000	STD	050	50 cm
41.945.99.0000	STD	055	55 cm
41.599.99.0000	STD	060	60 cm
41.946.99.0000	STD	065	65 cm
41.947.99.0000	STD	070	70 cm
41.948.99.0000	STD	075	75 cm



- Coated cotton
- Food safe
- Welded seam
- Useable several times
- Impermeabile

- Cotone rivestito
- Adatto al contatto con gli alimenti
- Cuciture saldate
- Riutilizzabile più volte
- Impermeabile

Espositore inox per bocchette e sac à poche

41.092.99.0000



Piping bags holder

PP Material
72.336.99.0098

- Sturdy
- with holes for 4 large and 4 small tubes

- Robusto
- con fori per 4 tubi grandi e 4 tubi piccoli



Kit sac à poche

STD034 Cotton piping bag
Size: 34 cm
+ 3 plastic round tubes
+ 3 plastic star tubes

70.033.99.0060



Silicone piping bags

Size: Ø 185 h 450 mm
70.300.86.0160

- Easy to fill
- It does not absorb any odour
- Ergonomic design
- It can be put in the freezer up to -76°F
- It can be used in the oven up to +446°F
- Dishwasher safe and sterilizable



- Facile da riempire
- Non assorbe odori né sapori
- Design ergonomico
- Utilizzabile in freezer fino a -60°C
- Utilizzabile in forno fino a +230°C
- Lavabile e sterilizzabile

Flower tube 01

Size: Ø 25 mm
43.421.99.0001



Flower tube 02

Size: Ø 25 mm
43.422.99.0001



Flower tube 03

Size: Ø 25 mm
43.423.99.0001



Flower tube 04

Size: Ø 25 mm
43.424.99.0001



Flower tube 05

Size: Ø 25 mm
43.425.99.0001



Flower tube 06

Size: Ø 25 mm
43.426.99.0001



Flower tube 07

Size: Ø 25 mm
43.427.99.0001



Flower tube 08

Size: Ø 25 mm
43.428.99.0001



Flower tube 09

Size: Ø 25 mm
43.429.99.0001



Flower tube 10

Size: Ø 25 mm
43.430.99.0001



Flower tube 12

Size: Ø 25 mm
43.432.99.0001



Flower tube 32

Size: Ø 25 mm
43.482.99.0001



Grass tube 13

Size: Ø 25 mm
43.433.99.0001



Grass tube 14

Size: Ø 25 mm
43.434.99.0001



Flower tube 17

Size: Ø 25 mm
43.437.99.0001



Flower tube 18

Size: Ø 25 mm
43.438.99.0001



Flower tube 19

Size: Ø 25 mm
43.439.99.0001



Flower tube 20

Size: Ø 25 mm
43.470.99.0001



Flower tube 21

Size: Ø 25 mm
43.471.99.0001



Flower tube 22

Size: Ø 25 mm
43.472.99.0001



Flower tube 23

Size: Ø 25 mm
43.473.99.0001



Flower tube 24

Size: Ø 25 mm
43.474.99.0001



Flower tube 25

Size: Ø 25 mm
43.475.99.0001



Flower tube 26

Size: Ø 25 mm
43.476.99.0001



Flower tube 27

Size: Ø 25 mm
43.477.99.0001



Flower tube 28

Size: Ø 25 mm
43.478.99.0001



Flower tube 29

Size: Ø 25 mm
43.479.99.0001



Flower tube 30

Size: Ø 25 mm
43.480.99.0001



Flower tube 33

Size: Ø 25 mm
43.483.99.0001



Flower tube 34

Size: Ø 25 mm
43.484.99.0001



Flower tube 35Size: Ø 25 mm
43.485.99.0001**Flower tube 36**Size: Ø 22 mm
43.486.99.0001**Flower tube 37**Size: Ø 25 mm
43.487.99.0001**Flower tube 38**Size: Ø 25 mm
43.488.99.0001**Flower tube 39**Size: Ø 25 mm
43.489.99.0001**Flower tube 40**Size: Ø 25 mm
43.490.99.0001**Snowflakes Tube**Size: Ø 25 mm
43.435.99.0001**Star tube**Size: Ø 25 mm
43.436.99.0001**Flower tube 41**Size: Ø 25 mm
43.491.99.0001**Flower tube 42**Size: Ø 25 mm
43.492.99.0001**Flower tube 43**Size: Ø 25 mm
43.493.99.0001**Flower tube 44**Size: Ø 25 mm
43.494.99.0001**Flower tube 45**Size: Ø 25 mm
43.495.99.0001**Flower tube 46**Size: Ø 25 mm
43.496.99.0001**Flower tube 47**Size: Ø 25 mm
43.497.99.0001**Flower tube 48**Size: Ø 25 mm
43.498.99.0001**Flower tube 49**Size: Ø 25 mm
43.499.99.0001**Flower tube 50**Size: Ø 25 mm
43.650.99.0001**Flower tube 51**Size: Ø 25 mm
43.651.99.0001**Flower tube 52**Size: Ø 25 mm
43.652.99.0001**Flower tube 53**Size: Ø 25 mm
43.653.99.0001**Flower tube 54**Size: Ø 25 mm
43.654.99.0001**Mini Flower tube 01**Size: Ø 18 mm
43.641.99.0001**Mini Flower tube 02**Size: Ø 18 mm
43.642.99.0001**Mini Flower tube 03**Size: Ø 18 mm
43.643.99.0001**Mini Flower tube 04**Size: Ø 18 mm
43.644.99.0001**Mini Flower tube 05**Size: Ø 18 mm
43.645.99.0001**Mini Flower tube 06**Size: Ø 18 mm
43.646.99.0001

Mini Flower tube 07Size: Ø 18 mm
43.647.99.0001**Mini Flower tube 08**Size: Ø 18 mm
43.648.99.0001**Ball tube regular**Size: Ø 25 mm
43.615.99.0001**Ball tube irregular**Size: Ø 25 mm
43.616.99.0001**Decor tube 07** **Mini decor tube 01**Size: Ø 25 mm
43.607.99.0001Size: Ø 18 mm
43.621.99.0001**Decor tube 01**Size: Ø 25 mm
43.601.99.0001**Mini decor tube 02**Size: Ø 18 mm
43.622.99.0001**Decor tube 05**Size: Ø 25 mm
43.605.99.0001**Mini decor tube 03**Size: Ø 18 mm
43.623.99.0001**Decor tube 06**Size: Ø 25 mm
43.606.99.0001**Mini decor tube 04**Size: Ø 18 mm
43.624.99.0001**Decor tube 09**Size: Ø 25 mm
43.609.99.0001**Mini decor tube 05**Size: Ø 18 mm
43.625.99.0001**Decor tube 04**Size: Ø 25 mm
43.604.99.0001**Mini decor tube 06**Size: Ø 18 mm
43.626.99.0001**Decor tube 10**Size: Ø 25 mm
43.610.99.0001**Decor tube 11**Size: Ø 25 mm
43.611.99.0001**Decor tube 02**Size: Ø 25 mm
43.602.99.0001**Mini decor tube 07**Size: Ø 18 mm
43.627.99.0001**Decor tube 03**Size: Ø 25 mm
43.603.99.0001**Mini decor tube 08**Size: Ø 18 mm
43.628.99.0001**Mini decor tube 10**Size: Ø 18 mm
43.630.99.0001**Mini decor tube 11**Size: Ø 18 mm
43.631.99.0001**Mini decor tube 12** **Mini decor tube 13**Size: Ø 18 mm
43.632.99.0001**Mini decor tube 14**Size: Ø 18 mm
43.634.99.0001**Mini decor tube 15**Size: Ø 18 mm
43.635.99.0001**Mini decor tube 09**Size: Ø 18 mm
43.629.99.0001

Color twist big

Size: Ø 25 mm
70.179.01.0096



Color twist small

Size: Ø 18 mm
70.178.01.0096



COLOR TWIST TUBES LIST

Small		Big
43.641.99.0001	43.421.99.0001	43.491.99.0001
43.642.99.0001	43.422.99.0001	43.492.99.0001
43.643.99.0001	43.423.99.0001	43.493.99.0001
43.644.99.0001	43.424.99.0001	43.494.99.0001
43.645.99.0001	43.425.99.0001	43.495.99.0001
43.646.99.0001	43.426.99.0001	43.496.99.0001
43.647.99.0001	43.427.99.0001	43.497.99.0001
43.648.99.0001	43.428.99.0001	43.498.99.0001
43.336.99.0000	43.429.99.0001	43.499.99.0001
43.337.99.0000	43.430.99.0001	43.450.99.0001
43.338.99.0000	43.431.99.0001	43.451.99.0001
43.339.99.0000	43.432.99.0001	43.452.99.0001
43.325.99.0000	43.433.99.0001	43.453.99.0001
43.326.99.0000	43.434.99.0001	43.454.99.0001
43.327.99.0000	43.435.99.0001	
43.387.99.0000	43.436.99.0001	
43.388.99.0000	43.437.99.0001	
43.389.99.0000	43.438.99.0001	
43.390.99.0000	43.439.99.0001	
43.310.99.0000	43.470.99.0001	
43.311.99.0000	43.471.99.0001	
43.312.99.0000	43.472.99.0001	
43.313.99.0000	43.473.99.0001	
43.314.99.0000	43.474.99.0001	
43.346.99.0000	43.475.99.0001	
43.347.99.0000	43.476.99.0001	
43.372.99.0000	43.477.99.0001	
43.375.99.0000	43.478.99.0001	
43.378.99.0000	43.479.99.0001	
43.369.99.0000	43.480.99.0001	
43.356.99.0000	43.481.99.0001	
43.357.99.0000	43.482.99.0001	
43.358.99.0000	43.483.99.0001	
43.360.99.0000	43.484.99.0001	
43.361.99.0000	43.485.99.0001	
43.350.99.0000	43.486.99.0001	
43.343.99.0000	43.487.99.0001	
43.344.99.0000	43.488.99.0001	
43.615.99.0001	43.489.99.0001	
43.616.99.0001	43.490.99.0001	

Tube Adaptor

Large Size: Ø 3 mm
70.182.01.0096
Medium Size: Ø 2.5 mm
70.181.01.0096
Small Size: Ø 1.5 mm
70.180.01.0096



ADAPTOR TUBES LIST

Small	Medium	Large
43.332.99.0000	43.336.99.0000	43.421.99.0001
43.333.99.0000	43.337.99.0000	43.422.99.0001
43.334.99.0000	43.338.99.0000	43.423.99.0001
43.335.99.0000	43.339.99.0000	43.424.99.0001
43.320.99.0000	43.325.99.0000	43.425.99.0001
43.321.99.0000	43.326.99.0000	43.426.99.0001
43.322.99.0000	43.327.99.0000	43.427.99.0001
43.323.99.0000	43.328.99.0000	43.428.99.0001
43.324.99.0000	43.388.99.0000	43.429.99.0001
43.379.99.0000	43.389.99.0000	43.430.99.0001
43.380.99.0000	43.390.99.0000	43.431.99.0001
43.381.99.0000	43.310.99.0000	43.432.99.0001
43.382.99.0000	43.311.99.0000	43.433.99.0001
43.383.99.0000	43.312.99.0000	43.434.99.0001
43.384.99.0000	43.313.99.0000	43.435.99.0001
43.385.99.0000	43.314.99.0000	43.436.99.0001
43.386.99.0000	43.346.99.0000	43.437.99.0001
43.301.99.0000	43.347.99.0000	43.438.99.0001
43.302.99.0000	43.372.99.0000	43.439.99.0001
43.303.99.0000	43.375.99.0000	43.470.99.0001
43.304.99.0000	43.378.99.0000	43.471.99.0001
43.305.99.0000	43.369.99.0000	43.472.99.0001
43.306.99.0000	43.356.99.0000	43.473.99.0001
43.307.99.0000	43.357.99.0000	43.474.99.0001
43.308.99.0000	43.358.99.0000	43.475.99.0001
43.309.99.0000	43.360.99.0000	43.476.99.0001
43.363.99.0000	43.361.99.0000	43.477.99.0001
43.364.99.0000	43.350.99.0000	43.478.99.0001
43.352.99.0000	43.343.99.0000	43.479.99.0001
43.366.99.0000	43.344.99.0000	43.480.99.0001
43.367.99.0000	43.615.99.0001	43.481.99.0001
43.368.99.0000	43.616.99.0001	43.482.99.0001
43.371.99.0000		43.483.99.0001
43.370.99.0000		43.484.99.0001
43.374.99.0000		43.485.99.0001
43.373.99.0000		43.486.99.0001
43.353.99.0000		43.487.99.0001
43.376.99.0000		43.488.99.0001
43.377.99.0000		43.489.99.0001
43.355.99.0000		43.490.99.0001
43.349.99.0000		43.491.99.0001
Mini Flower		43.492.99.0001
Bin Media		43.493.99.0001
Bin Grande		43.494.99.0001
		43.495.99.0001
		43.496.99.0001
		43.497.99.0001
		43.498.99.0001
		43.499.99.0001
		43.450.99.0001
		43.451.99.0001
		43.452.99.0001
		43.453.99.0001
		43.454.99.0001



Star french tubes

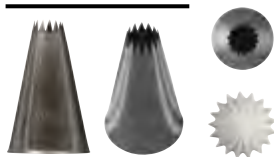

Name	Item	Size
BF 310	43.332.99.0000	Ø 4 mm
BF 311	43.333.99.0000	Ø 6 mm
BF 312	43.334.99.0000	Ø 7 mm
BF 313	43.335.99.0000	Ø 9 mm
BF 314	43.336.99.0000	Ø 10 mm
BF 314/11	43.337.99.0000	Ø 11 mm
BF 315	43.338.99.0000	Ø 12 mm
BF 316	43.339.99.0000	Ø 13 mm
BF 317	43.340.99.0000	Ø 15 mm
BF 318	43.341.99.0000	Ø 16 mm
BF 319	43.342.99.0000	Ø 18 mm

BX 10 S

Size: da Ø 4 a 15 mm
Set 10 pz/pcs
43.097.99.0000



Round tubes



Name	Item	Size
BT 202	43.301.99.0000	Ø 2 mm
BT 203	43.302.99.0000	Ø 3 mm
BT 204	43.303.99.0000	Ø 4 mm
BT 205	43.304.99.0000	Ø 5 mm
BT 206	43.305.99.0000	Ø 6 mm
BT 207	43.306.99.0000	Ø 7 mm
BT 208	43.307.99.0000	Ø 8 mm
BT 209	43.308.99.0000	Ø 9 mm
BT 210	43.309.99.0000	Ø 10 mm
BT 211	43.310.99.0000	Ø 11 mm
BT 212	43.311.99.0000	Ø 12 mm
BT 213	43.312.99.0000	Ø 13 mm
BT 214	43.313.99.0000	Ø 14 mm
BT 215	43.314.99.0000	Ø 15 mm
BT 216	43.315.99.0000	Ø 16 mm
BT 217	43.316.99.0000	Ø 17 mm
BT 218	43.317.99.0000	Ø 18 mm
BT 220	43.318.99.0000	Ø 20 mm
BT 222	43.319.99.0000	Ø 22 mm
BT 224	43.320.99.0000	Ø 24 mm

Close star tubes



Name	Item	Size
BC 320	43.321.99.0000	Ø 2 mm
BC 321	43.322.99.0000	Ø 3 mm
BC 322	43.323.99.0000	Ø 4 mm
BC 323	43.324.99.0000	Ø 5 mm
BC 324	43.325.99.0000	Ø 6 mm
BC 325	43.326.99.0000	Ø 7 mm
BC 326	43.327.99.0000	Ø 8 mm
BC 327	43.328.99.0000	Ø 9 mm
BC 328	43.329.99.0000	Ø 10 mm
BC 329	43.330.99.0000	Ø 11 mm
BC 330	43.331.99.0000	Ø 12 mm

Open flower tubes



Name	Item	Size
BA 411	43.346.99.0000	small
BA 413	43.347.99.0000	medium
BA 415	43.348.99.0000	large

BS 10 T

Size: da Ø 4 a 15 mm
Set 10 pz/pcs
43.096.99.0000



Open flower leaves



Name	Item	Size
BX1105	43.362.99.0000	Ø 5 h 42 mm
BX1115	43.363.99.0000	Ø 4 h 42 mm
BX1123	43.364.99.0000	Ø 3 h 42 mm
BX1132	43.365.99.0000	Ø 2 h 42 mm

Star tubes



Name	Item	Size
BS 102	43.379.99.0000	Ø 2 mm
BS 103	43.380.99.0000	Ø 3 mm
BS 104	43.381.99.0000	Ø 4 mm
BS 105	43.382.99.0000	Ø 5 mm
BS 106	43.383.99.0000	Ø 6 mm
BS 107	43.384.99.0000	Ø 7 mm
BS 108	43.385.99.0000	Ø 8 mm
BS 109	43.386.99.0000	Ø 9 mm
BS 110	43.387.99.0000	Ø 10 mm
BS 111	43.388.99.0000	Ø 11 mm
BS 112	43.389.99.0000	Ø 12 mm
BS 113	43.390.99.0000	Ø 13 mm
BS 114	43.391.99.0000	Ø 14 mm
BS 115	43.392.99.0000	Ø 15 mm
BS 116	43.393.99.0000	Ø 16 mm
BS 117	43.394.99.0000	Ø 17 mm
BS 118	43.395.99.0000	Ø 18 mm

Star ribbon tubes



Name	Item	Size
BR 330	43.343.99.0000	small
BR 331	43.344.99.0000	medium
BR 332	43.345.99.0000	large

Flower tubes



Name	Item	Size
BD 300	43.349.99.0000	small
BD 301	43.350.99.0000	medium
BD 302	43.351.99.0000	large

BX 1013



Name	Item	Size
BX1013	43.352.99.0000	Ø 13 h 43 mm

BX 1303



Name	Item	Size
BX1303	43.367.99.0000	3 x 17 h 40 mm

BX 1217



Name	Item	Size
BX1217	43.366.99.0000	3 x 17 h 40 mm

BX 1405



Name	Item	Size
BX1405	43.368.99.0000	5 x 20 h 43 mm

BX 1510



Name	Item	Size
BX1510	43.369.99.0000	10x22h52mm

BX 1713



Name	Item	Size
BX1713	43.371.99.0000	Ø 13 h 40 mm

BX 1605



Name	Item	Size
BX1605	43.370.99.0000	8 x 5 h 52 mm

BX 1820



Name	Item	Size
BX1820	43.372.99.0000	Ø 20 h 42 mm

BX 2117



Name	Item	Size
BX2117	43.374.99.0000	Ø 17 h 45 mm

BX 1906



Name	Item	Size
BX1906	43.373.99.0000	Ø 17 x 6 h 47 mm

BX 2013



Name	Item	Size
BX2013	43.353.99.0000	Ø 13 h 42 mm

BX 2219



Name	Item	Size
BX2219	43.375.99.0000	Ø 19 h 52 mm

BX 2312 - BX2314 - BX2315



Name	Item	Size
BX2312	43.376.99.0000	Ø12 h 41mm
BX2314	43.377.99.0000	Ø 14 h 39 mm
BX2315	43.378.99.0000	Ø15 h 46 mm

BX 6018



Name	Item	Size
BX6018	43.357.99.0000	Ø18 h 48 mm

BX 8019



Name	Item	size
BX8019	43.359.99.0000	Ø19 h 52 mm

Rectangle tube 01

Size: 15 x 25 mm
43.597.99.0001



BX 3005



Name	Item	Size
BX3005	43.354.99.0000	Ø 5 h 50 mm

BX 4014



Name	Item	Size
BX4014	43.355.99.0000	Ø 14 h 50 mm

BX 9017



Name	Item	size
BX9017	43.360.99.0000	3x17h52mm
BX9022	43.361.99.0000	3x 22h53mm

Square tube 02

Size: 15 x 20 mm
43.596.99.0001



BX 5017



Name	Item	Size
BX5017	43.356.99.0000	Ø17 h 47 mm

BX 7020



Name	Item	Size
BX7020	43.358.99.0000	Ø20 h 52 mm

BIM 340

Name	Item
Ø25 x 90 mm	70.529.99.0066
Ø6 x 63 mm	43.457.99.0001
Ø6 x 75 mm	43.458.99.0001
Ø8 x 92 mm	43.459.99.0001

Ideale per riempire cannoli, krafpen e bigné
Perfect for stuff cream horns, krafpens, cream puffs



Tube Cleaning Brush

Name	Item
BRU	41.090.99.0000





BOS 52

Set 52 pz/pcs
40.716.00.0000



BOS 36 BIG

Set 36 pz/pcs
40.454.99.0000



BOS 26

Set 26 pz/pcs
40.805.99.0000



BPC 6C

Tubes
Set 6 pz/pcs
73.103.99.0096
polycarbonate



BPC 12A

Star Tubes + Round tubes
Set 12 pz/pcs
73.104.99.0096
polycarbonate



BPC 6A

Star Tubes
Set 6 pz/pcs
73.101.99.0096
polycarbonate



BPC 12B

Mixed Tubes
Set 12 pz/pcs
73.105.99.0096
polycarbonate

Religieuse tube 01

Close
Size: Ø 30 mm
43.443.99.0001



Religieuse tube 02

Open
Size: Ø 30 mm
43.444.99.0001



Sugarflex

Dresses & Tools - Abiti & Accessori

SLK 198 - Bow

item: 71.298.00.0096

size: 44 x 45 mm



SLK 199 - Bows

item: 71.299.00.0096

size max: 35 x 25 mm



SLK 340 - Medium bows

item: 71.440.00.0096

size max: 18 x 13 mm



SLK 339 - Love bows

item: 71.439.00.0096

size max: 15 x 20 mm



SLK 281 - Crowns

item: 71.381.00.0096

size max: 58 x 24 mm



Animals - Animali

SLK 306 - Butterflies

item: 71.406.00.0096

size max: 44 x 28 mm



SLK 073 - Starfish

item: 71.173.00.0096

size: 50 x 50 mm



SLK 071 - Dolphin

item: 71.171.00.0096

size: 78 x 50 mm



SLK 077 - Shell

item: 71.177.00.0096

size: 44 x 47 mm



SLK 021 - Dinosaurs

item: 71.121.00.0096

size max: 15 x 20 mm



Baby Party

SLK 312 - Sleeping baby

item: 71.412.00.0096

size: 48 x 35 mm



SLK 403 - Sleeping baby

item: 71.503.00.0096

size: 10 x 20 mm



FAIRY TALE - FIABA

SLK 041 - Rabbit

item: 71.141.00.0096

size: 53 x 43 mm



SLK 141 - Rabbit

item: 71.241.00.0096

size: 53 x 43 mm



SLK 164 - Train

item: 71.264.00.0096

size: 50 x 25 mm



SLK 247 - Pirates

item: 71.347.00.0096

size max: 50 x 42 mm



SLK 311 - Baby footsteps

item: 71.411.00.0096

size max: 25 x 16 mm



SLK 326 - Big numbers

item: 71.426.00.0096

size max: 27 x 17 mm



SLK 016 - Clown

item: 71.116.00.0096

size: 65 x 30 mm



SLK 425 Ballon

item: 71.525.86.0096

size: Ø 120 mm



SLK 328 - Alphabet

item: 71.428.00.0096

size max: 18 x 15 mm



SLK 329 - Alphabet cursive

item: 71.429.00.0096

size max: 7 x 6 mm



Decorations - Decori

SLK 144 - Decoro

item: 71.244.00.0096

size: 53 x 25 mm



SLK 146 - Decoro

item: 71.246.00.0096

size: 40 x 42 mm



SLK 393 - Decoro

item: 71.493.00.0096

size: 125 x 20 mm



FLOWERS - FIORI

SLK 295 - Roses

item: 71.395.00.0096

size max: 25 x 25 mm



SLK 241 - Flower

item: 71.341.00.0096

size max: 24 x 24 mm



SLK 066 - Rose

item: 71.166.00.0096

size: 42 x 49 mm



SLK 355 - Roses
item: 71.455.00.0096
size max: 16 x 15 mm



SLK 346 - Wild flowers
item: 71.446.00.0096
size max: 35 x 32 mm



SLK 351 - Flowers
item: 71.451.00.0096
size max: 22 x 23 mm



SLK 384 - Rose
item: 71.484.00.0096
size max: 33 x 33 mm



SLK 380 - Palmes
item: 71.480.00.0096
size max: 52 x 40 mm



LOVE - AMORE

SLK 142 - Cross
item: 71.242.00.0096
size max: 36 x 48 mm



CHRISTMAS - NATALE

SLK 131 - Snowflake
item: 71.231.00.0096
size max: 30 x 35 mm



LEAVES AND FLOWERS - FOGLIE E FIORI

Silicone moulds to make wonderful modeling paste leaves and flowers!

Venatori in silicone per la realizzazione di splendide foglie e fiori in pasta modellabile!



SLK 921
item: 71.921.86.0096
size: 30 x 49 mm



SLK 908
item: 71.908.86.0096
size: 100 x 60 mm





SLK 801 - FIORE/BLOSSOM

Size: Ø 37 mm
71.801.39.0096



SLK 804 - ORTENSIA/HYDRANGEA

Size: 27 x 27 mm
71.804.39.0096



SLK 803 - MARGHERITA/DAISY

Size: Ø 32 mm
71.803.39.0096



SLK 805 - PETUNIA
Size: Ø 40 mm
71.805.39.0096



SLK 802 - FIORE DI CILIEGIO/CHERRY BLOSSOM

Size: Ø 30 mm
71.802.39.0096



SLK 806 - FARFALLA/BUTTERFLY

Size: 37 x 30 mm
71.806.39.0096



SLK 817 - MINI IVY

Size: 35 x 30 x 30 mm
71.817.39.0096



SLK 818 - IVY

Size: 45 x 42 x 28 mm
Item: 71.818.39.0096





SLK 807 - MINI FRANGIPANI

Size: Ø 30 mm
71.807.39.0096



SLK 808 - FRANGIPANI

Size: Ø 37 mm
71.808.39.0096



SLK 809 - MINI LILAC

Size: Ø 33 mm
71.809.39.0096



SLK 810 - LILAC

Size: Ø 40 mm
71.810.39.0096



SLK 811 - MINI STAR FLOWER

Size: Ø 31 mm
71.811.39.0096



SLK 812 - STAR FLOWER

Size: Ø 35 mm
Item: 71.812.39.0096



SLK 813 - MINI SPRING

Size: Ø 30 mm
71.813.39.0096



SLK 814 - SPRING

Size: Ø 35 mm
71.814.39.0096



SLK 815 - MINI leaf

Size: Ø 31 mm
71.815.39.0096



SLK 816 - leaf

Size: Ø 35 mm
71.816.39.0096



CAKE DESIGN



Cake Design

Imagination, design research and creativity: three words which perfectly express the world of cake design. Here you will find all the products dedicated to the world of cake design to decorate your monumental and ceremonial cakes. In order to achieve perfection, quality makes all the difference. Choose your style, free your imagination and create your own culinary work of art.

Fantasia, ricerca nel design e creatività: tre parole che esprimono perfettamente il mondo del cake design. Qui troverai tutti i prodotti dedicati al mondo del cake design per decorare le tue torte a piani e da cerimonia. Per raggiungere la perfezione, è la qualità a fare la differenza. Scegli il tuo stile, libera la tua immaginazione e crea la tua opera d'arte culinaria.



TRD03 FLOWER

Size: 80 x 400 h 1,8 mm
23.083.87.0196



TRD08 CHIC

Size: 400 x 200 h 1,8 mm
23.088.87.0196



TRD13 BIRDS

Size: 80 x 400 h 1,8 mm
23.093.87.0069



TRD05 SLIM FANTASY

Size: 65 x 400 h 1,8 mm
23.085.87.0096



TRD08 SLIM CHIC

Size: 65 x 400 h 1,8 mm
23.088.87.0096



RP02 RIGHE

Size: Ø 42 x 400 mm
70.302.19.0069



RP03 CUORI

Size: Ø 42 x 400 mm
Item: 70.303.19.0069



WMAT01 - POIS

Size: 600 x 400 h 3 mm
23.063.19.0069



WMAT02 - MATELASSÉ

Size: 600 x 400 h 3 mm
23.062.19.0069

PRECISION MAT

Size: 400 x 300 mm
23.014.19.0069



WONDER POPS

Size: Ø 30 mm
Volume: 224 ml
25.321.87.0165



36 Sticks



EC03 SWEET TREATS

Volume: 16 x 3,5 ml Tot.: 57 ml
GIFT BOX - Item: 22.753.35.0069



LIS01 SMOOTHER

Item: 70.098.99.0069



LIS02 SMOOTHER EDGE

Item: 70.099.99.0069





FOOTBALL

Set 24 Pcs
70.172.02.0065



SNOWMAN

Set 24 Pcs
70.171.02.0063



SKULL

Set 24 Pcs
70.171.01.0063



TEATIME

Set 24 Pcs
70.171.04.0063



CUPCAKES

Set 24 Pcs
70.171.03.0063



BALLONS

Set 24 Pcs
70.171.05.0063



HEARTS

Set 24 Pcs
70.172.03.0065



WEDDING

Set 24 Pcs
70.172.01.0065



WINTER

Set 24 Pcs
70.172.04.0065



PARTY

Set 24 Pcs
70.172.05.0065





ACC088 MINI COOKIE
CUTTER NATURE

Item: 70.111.99.0069
49 x 50 h 18 mm



ACC089 MINI COOKIE
CUTTER LOVE

Item: 70.112.99.0069
50 x 43 h 18 mm



ACC090 MINI COOKIE
CUTTER EASTER

Item: 70.113.99.0069
50 x 36 h 18 mm



ACC093 MINI COOKIE
CUTTER ANIMALS

Item: 70.116.99.0069
47 x 45 h 18 mm



ACC096 MINI COOKIE
CUTTER SUMMER

Item: 70.119.99.0069
47 x 47 h 18 mm



ACC104 MINI COOKIE
CUTTER JINGLE BELLS

Item: 70.123.99.0069
42 x 47 h 18 mm



ACC101 MINI COOKIE
CUTTER FUNNY ANIMAL

Item: 70.120.99.0069
47 x 45 h 18 mm



i78
by Silikomart

VELVET SPRAY OIL BASED

VELVET SPRAY BASE OLIO

The new oil-based spray delivers the same high-end decorative effect as cocoa butter sprays. It also guaranteed perfect results on non-frozen products, such as puddings, mousses, and more. Also suitable for decorating preparations covered with buttercream. This is a real plus for professionals and home users, offering greater versatility in everyday applications.

Il nuovo spray a base di olio offre lo stesso effetto decorativo di alta qualità degli spray al burro di cacao. Garantisce inoltre risultati perfetti anche su prodotti non congelati, come budini, mousse e altro ancora. È adatto anche per decorare preparazioni ricoperte di crema al burro. Un vero vantaggio per i professionisti e per gli appassionati di cucina, che possono così contare su una maggiore versatilità nelle applicazioni quotidiane.

• E171 FREE

• OGM FREE

• GLUTEN FREE

VELVET SPRAY OIL-BASED 250 ml / 400 ml

VELVET SPRAY BASE OLIO 250 ml / 400 ml

VELVET SPRAY OIL-BASED WHITE

Item: 99.545.02.0001
Size: 250 ml

Item: 99.546.02.0001
Size: 400 ml



VELVET SPRAY OIL-BASED BROWN

Item: 99.545.04.0001
Size: 250 ml

Item: 99.546.04.0001
Size: 400 ml



VELVET SPRAY OIL-BASED YELLOW

Item: 99.545.03.0001
Size: 250 ml

Item: 99.546.03.0001
Size: 400 ml



VELVET SPRAY OIL-BASED RED

Item: 99.545.06.0001
Size: 250 ml

Item: 99.546.06.0001
Size: 400 ml



VELVET SPRAY OIL-BASED GREEN

Item: 99.545.07.0001
Size: 250 ml

Item: 99.546.07.0001
Size: 400 ml



250 ML



400 ML

VELVET SPRAY

VELVET SPRAY BASE CACAO

Food grade velvet spray for the decoration of frozen preparations. Cocoa butter spray, perfect for mousses, entremets and frozen products in general. Shake well before and during using. Spray evenly with small pressures a thin and homogeneous layer keeping about 50 cm from the frozen surface. Carefully follow the instructions on the label.

Colorante alimentare spray effetto velluto per decorare preparazioni congelate. Burro di cacao spray, perfetto per mousse, entremet e prodotti congelati in genere. Agitare bene prima e durante l'uso. Spruzzare uniformemente con piccole pressioni uno strato sottile ed omogeneo mantenendo una distanza di circa 50 cm dalla superficie congelata. Seguire attentamente le istruzioni riportate in etichetta.

• E171 FREE

• OGM FREE

• GLUTEN FREE

• PALM OIL FREE



VELVET SPRAY GOLD

Item: 99.516.09.0001
Size: 250ml



VELVET SPRAY GOLD

Item: 99.534.09.0001
Size: 400ml



VELVET SPRAY LIGHT BLUE

Item: 99.516.10.0001
Size: 250ml



VELVET SPRAY LIGHT BLUE

Item: 99.534.10.0001
Size: 400ml



VELVET SPRAY ORANGE

Item: 99.516.01.0001
Size: 250ml



VELVET SPRAY ORANGE

Item: 99.534.01.0001
Size: 400ml



VELVET SPRAY LIME

Item: 99.516.11.0001
Size: 250ml



VELVET SPRAY LIME

Item: 99.534.11.0001
Size: 400ml



VELVET SPRAY LIGHT BROWN

Item: 99.516.12.0001
Size: 250ml



• E171 FREE

• OGM FREE

• GLUTEN FREE

• PALM OIL FREE



**VELVET SPRAY
LIGHT BROWN**

Item: 99.534.12.0001
Size: 400ml



**VELVET SPRAY
YELLOW**

Item: 99.516.03.0001
Size: 250ml



**VELVET SPRAY
YELLOW**

Item: 99.534.03.0001
Size: 400ml



**VELVET SPRAY
CHERRY RED**

Item: 99.516.13.0001
Size: 250ml



**VELVET SPRAY
CHERRY RED**

Item: 99.534.13.0001
Size: 400ml



**VELVET SPRAY
FUCSIA**

Item: 99.516.14.0001
Size: 250ml



**VELVET SPRAY
FUCSIA**

Item: 99.534.14.0001
Size: 400ml



**VELVET SPRAY
PINK**

Item: 99.516.05.0001
Size: 250ml



**VELVET SPRAY
PINK**

Item: 99.534.05.0001
Size: 400ml



**VELVET SPRAY
BUTTER WHITE**

Item: 99.516.15.0001
Size: 250ml



**VELVET SPRAY
BUTTER WHITE**

Item: 99.534.15.0001
Size: 400ml



**VELVET SPRAY
LILAC**

Item: 99.516.17.0001
Size: 250ml



• E171 FREE

• OGM FREE

• GLUTEN FREE

• PALM OIL FREE



VELVET SPRAY PURPLE

Item: 99.534.16.0001
Size: 400ml



VELVET SPRAY GREEN

Item: 99.516.07.0001
Size: 250ml



VELVET SPRAY GREEN

Item: 99.534.07.0001
Size: 400ml



VELVET SPRAY RED

Item: 99.516.06.0001
Size: 250ml



VELVET SPRAY RED

Item: 99.534.06.0001
Size: 400ml



VELVET SPRAY BROWN

Item: 99.516.04.0001
Size: 250ml



VELVET SPRAY BROWN

Item: 99.534.04.0001
Size: 400ml



VELVET SPRAY WHITE

Item: 99.516.02.0001
Size: 250ml



VELVET SPRAY WHITE

Item: 99.534.02.0001
Size: 400ml



VELVET SPRAY BLACK

Item: 99.516.08.0001
Size: 250ml



VELVET SPRAY BLACK

Item: 99.534.08.0001
Size: 400ml



METALLIC SPRAY

SPRAY METALLIZZATI

Food grade metallic spray for the decoration of frozen preparations. Cocoa butter spray, perfect for mousses, entremets and frozen products in general. Shake well before and during using. Spray evenly with small pressures a thin and homogeneous layer keeping about 25/30 cm from the frozen surface. Carefully follow the instructions on the label.

Colorante alimentare spray effetto metalizzato per decorare preparazioni congelate. Burro di cacao spray, perfetto per mousse, entremet e prodotti congelati in genere. Agitare bene prima e durante l'uso. Spruzzare uniformemente con piccole pressioni uno strato sottile ed omogeneo mantenendo una distanza di circa 25/30 cm dalla superficie congelata. Seguire attentamente le istruzioni riportate nell'etichetta.

• E171 FREE

• OGM FREE

• AZO FREE

• GLUTEN FREE

• PALM OIL FREE



METALLIC SPRAY GOLD

Item: 99.536.01.0001

Size: 250ml



METALLIC SPRAY SILVER

Item: 99.536.02.0001

Size: 250ml



EXTRA FINE GLITTERING POWDER

GLITTER DUST POLVERE SCINTILLANTE EXTRA FINE

Mixture of foodgrade pearlescent powdered colors, with an air pump, ideal for decorations and for coloring the surface of: sugar-based products, chocolate, butter cream, meringues, fatty masses in general.

Miscela di coloranti perlescente, in polvere, per uso alimentare con pompetta ad aria, ideale per decorazioni e per la colorazione in superficie di: prodotti a base di zucchero, cioccolato, crema al burro, meringhe, masse grasse in generale.

• E171 FREE

• OGM FREE

• AZO FREE

• GLUTEN FREE

• PALM OIL FREE



GLITTER DUST SILVER

Item: 99.507.09.0001

Size: 10g



GLITTER DUST BRONZE

Item: 99.507.02.0001

Size: 10g



GLITTER DUST PINK

Item: 99.507.12.0001

Size: 10g



GLITTER DUST GOLD

Item: 99.507.10.0001

Size: 10g



GLITTER DUST RED

Item: 99.507.04.0001

Size: 10g



GLITTER DUST LIGHT BLUE

Item: 99.507.14.0001

Size: 10g



GLITTER DUST GREEN

Item: 99.507.13.0001

Size: 10g



GLITTER DUST YELLOW

Item: 99.507.11.0001

Size: 10g



PEARL COLOUR

COLORE PERLATO

Pearly food colouring powder

Colorante alimentare perlato in polvere



COPPER

Item: 99.511.02.0001

Size: 20g



GOLD

Item: 99.511.05.0001

Size: 20g



RED

Item: 99.511.04.0001

Size: 20g



GLAZE SPRAY

GLASSA SPRAY

Ready-to-use glossy spray glaze for preparations at both positive and negative temperatures of any shape.

Glassa lucida spray pronta all'uso per preparazioni a temperatura sia positiva che negativa di ogni forma.

Conceived with
**Tommaso
Foglia**



• Easy to use / Facile da usare

• Professional results in just seconds / Riuscita professionale in pochi secondi

• Maximum versatility of use on any shape / Massima versatilità di utilizzo su ogni forma

• Product intended for glazing water-based semifreddo desserts. Not suitable for glazing fat-based products including chocolate. / Prodotto indicato per il glassaggio di semifreddi a base acquosa. Non adatto al glassaggio di prodotti a base grassa incluso cioccolato.

• With Bag-On-Valve technology, every spray is precise and even, even when using the can in tilted or upside-down positions - no surprises, just perfect results. / Con la tecnologia Bag-On-Valve, ogni spruzzo è preciso e uniforme, anche quando utilizzi la bombola in posizioni inclinate o capovolta - zero imprevisti, solo risultati perfetti.

• Plus, the gas never comes into contact with the glaze, ensuring colour and flavour stay intact, with no risk of oxidation. / In più, il gas non entra mai in contatto con la glassa: questo significa colore e sapore sempre intatti, senza rischi di ossidazione.

• And there's more: the system lets you use the product right down to the last drop, minimising waste. All this with non-hazardous gases, for a safe and responsible use. / E non finisce qui: il sistema permette di sfruttare il prodotto fino all'ultima goccia, evitando sprechi inutili. Il tutto con gas non pericolosi, per un utilizzo sicuro e responsabile.



GLAZE SPRAY 280 gr GLASSA SPRAY 280 gr



RED

Item: 99.549.01.0001
Size: 280 gr



YELLOW

Item: 99.549.05.0001
Size: 280 gr



GREEN

Item: 99.549.03.0001
Size: 280 gr



BLUE

Item: 99.549.06.0001
Size: 280 gr



TRANSPARENT

Item: 99.549.02.0001
Size: 280 gr



BROWN

Item: 99.549.04.0001
Size: 280 gr



THE ONE MIRROR GLAZE

GLASSA A SPECCHIO

The only powdered mirror glaze preparation that ensures the same results as the one prepared by hand. A single product to create multiple glazes. Easy to use (it is practically impossible to fail), it does not require the addition of other ingredients but only water ... It can't get easier than that! Furthermore, The One Mirror Glaze by i78 by Silikomart can be flavored with concentrated or chocolate pastes and coloured with water-soluble colourants (including natural ones). Available in two sizes: 300g and 1Kg pot to meet the needs of all consumers. The One Mirror Glaze powdered mirror glaze guarantees a transparent and shiny result, which is maintained even at negative temperatures.

L'unico preparato per glassa a specchio in polvere che assicura gli stessi risultati di quella preparata a mano. Un unico prodotto per creare molteplici glassa. Facile da usare (è praticamente impossibile sbagliare), non richiede l'aggiunta di altri ingredienti ma solo acqua...più facile di così! Inoltre The One Mirror Glaze di i78 by Silikomart può essere aromatizzata con paste concentrate o cioccolato e colorata con coloranti idrosolubili (anche naturali). Disponibile in due formati: barattolo da 300g e da 1 kg per rispondere alle esigenze di tutti i consumatori. La glassa a specchio in polvere The One Mirror Glaze garantisce un risultato trasparente e brillante, che si mantiene anche a temperature negative.



THE ONE MIRROR GLAZE

Item: 99.523.02.0001

Size: 1 Kg



THE ONE MIRROR GLAZE

Item: 99.524.02.0001

Size: 300 g

THE BENEFITS OF THE ONE MIRROR GLAZE BY I78 BY SILIKOMART

I PLUS DI THE ONE MIRROR GLAZE DI I78 BY SILIKOMART

- Easy to use
 - Versatile
 - No ingredients to add, just water
 - Will always be a success
 - Customizable in different colours
 - It can be flavored with concentrated pastes
 - Easy to store
 - Easy to dose
 - Quick to prepare
- Facile da utilizzare
 - Versatile
 - Nessun ingrediente da aggiungere, solo acqua
 - Sarà sempre un successo
 - Personalizzabile in diversi colori
 - Si può aromatizzare con paste concentrate
 - Facile da conservare
 - Facile da dosare
 - Veloce da preparare

HOW TO USE

MODO D'USO

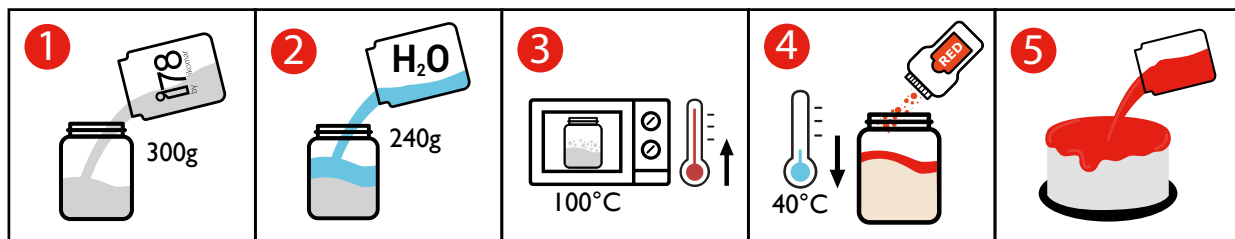

1. POUR 300g of The One Glaze and 240g of water.
2. MIX with the hand blender.
3. HEAT until boiling.
4. MIX & COLOUR.
5. USE at 40°C / 104°F on frozen cakes, semifreddo, mousses, bavarians.

1. VERSA 300g di The One Glaze e 240 g d'acqua.
2. MESCOLA con il frullatore ad immersione.
3. SCALDA fino ad ebollizione.
4. MESCOLA & COLORA.
5. UTILIZZA a 40°C su torte fredde, semifreddi, mousse, bavaresi.



Watch the video
Guarda il video



READY TO USE MIRROR GLAZE

GLASSA A SPECCHIO PRONTA ALL'USO

Mirror glaze ready to use. It is perfect to be used as a cover for semifreddos, mousses, bavarian creams and any cold dessert. The glaze is glossy, fluid and super easy to use. You can colour the mirror glaze with powdered or gel food colouring.

Glassa a specchio pronta all'uso. Perfetta per essere utilizzata come copertura di semifreddi, mousse, bavaresi e qualsiasi dessert freddo. La glassa è lucida, fluida e semplicissima da usare. È possibile colorare la glassa a specchio con coloranti alimentari in polvere o in gel.



READY MADE MIRROR GLAZE RED

Item: 99.505.05.0001

Size: 250g



READY MADE MIRROR GLAZE CHOCO

Item: 99.505.03.0001

Size: 250g



READY MADE MIRROR GLAZE NEUTRAL

Item: 99.505.00.0001

Size: 225g



OIL-BASED LIPO COLOR





































COLORANTI LIPO BASE OLIO

Concentrated oil-based fat-soluble colourings, ready to use and ideal for professional results. They are perfect for colouring chocolate, buttercream, sugar paste and all fat-based preparations. Their high solubility guarantees intense, bright colours with just a few drops, which distribute evenly with a simple stir, without the need for a blender and without forming lumps.

Coloranti liposolubili concentrati a base oleosa, pronti all'uso e ideali per risultati professionali. Sono perfetti per colorare cioccolato, crema al burro, pasta di zucchero e tutte le preparazioni a base grassa. L'elevata solubilità garantisce colori intensi e brillanti già con poche gocce, che si distribuiscono in modo uniforme con una semplice mescolata, senza bisogno di frullatore e senza formazione di grumi.



Size: 25 ml

ITEM	COLOR	AZO FREE	E171 FREE	OGM FREE	GLUTEN FREE	VEGAN FRIENDLY
99.550.01.0001	PURPLE 					
99.550.02.0001	HOT PINK 					
99.550.03.0001	RED 					
99.550.04.0001	YELLOW 					
99.550.05.0001	SKY BLUE 					
99.550.06.0001	DARK GREEN 					
99.550.07.0001	BLACK 					

POWDERED FOOD COLOURING

COLORANTI IN POLVERE

WATER-SOLUBLE FOOD COLOURING POWDER

COLORANTE ALIMENTARE IDROSOLUBILE IN POLVERE

- E171 FREE
- OGM FREE
- AZO FREE
- GLUTEN FREE

IDRO COLOR - 5g



ORANGE

Item: 99.509.01.0065

Size: 5g



BLUE

Item: 99.509.02.0065

Size: 5g



YELLOW

Item: 99.509.03.0065

Size: 5g



BROWN

Item: 99.509.04.0065

Size: 5g



RED

Item: 99.509.05.0065

Size: 5g



GREEN

Item: 99.509.06.0065

Size: 5g

IDRO COLOR - 25g



ORANGE

Item: 99.508.01.0001

Size: 25g



BLUE

Item: 99.508.02.0001

Size: 25g



YELLOW

Item: 99.508.03.0001

Size: 25g



BROWN

Item: 99.508.04.0001

Size: 25g



RED

Item: 99.508.05.0001

Size: 25g



GREEN

Item: 99.508.06.0001

Size: 25g

The water-soluble or fat-soluble food colours in powder are highly concentrated and they have a high pigmentation power. Thanks to the high quality of the product, a very small amount will be sufficient to color sugar paste, marzipan, icing, meringue, chocolate, mousse, icing and much more.

I Coloranti alimentari idrosolubili o liposolubili in polvere sono ad alta concentrazione e ad alto potere di pigmentazione. Grazie all'alta qualità del colorante, sarà sufficiente una piccolissima quantità per colorare paste di zucchero, marzapane, glassa, meringa, cioccolato, mousse, glasse e molto altro.

Cake
Torta

Meringue
Meringa

Cream
Cremoso

Ice-cream
Gelato

Glaze
Glassa



Dosage: 0,04g/Kg

Dosage: 0,33g/Kg

Dosage: 0,04g/Kg

Dosage: 0,04g/Kg

Dosage: 0,04g/Kg



Dosage: 0,55g/Kg

Dosage: 0,50g/Kg

Dosage: 0,1g/Kg

Dosage: 0,2g/Kg

Dosage: 0,53g/Kg



Dosage: 0,55g/Kg

Dosage: 0,53g/Kg

Dosage: 0,2g/Kg

Dosage: 0,34g/Kg

Dosage: 0,53g/Kg



Dosage: 0,70g/Kg

Dosage: 0,70g/Kg

Dosage: 0,2g/Kg

Dosage: 0,5g/Kg

Dosage: 0,54g/Kg



Dosage: 0,55g/Kg

Dosage: 0,53g/Kg

Dosage: 0,04g/Kg

Dosage: 0,5g/Kg

Dosage: 0,53g/Kg



Dosage: 0,55g/Kg

Dosage: 0,50g/Kg

Dosage: 0,1g/Kg

Dosage: 0,3g/Kg

Dosage: 5,34g/Kg

FAT-SOLUBLE FOOD COLOURING POWDER

COLORANTE ALIMENTARE LIPOSOLUBILE IN POLVERE

• E171 FREE

• OGM FREE

• AZO FREE

• GLUTEN FREE



LIPO COLOR - 20g

ORANGE

Item: 99.510.01.0001

Size: 20g

Chocolate
Cioccolato



Dosage: 0,1g/Kg



BLUE

Item: 99.510.02.0001

Size: 20g



Dosage: 1,9g/Kg



YELLOW

Item: 99.510.03.0001

Size: 20g



Dosage: 1,2g/Kg



BROWN

Item: 99.510.04.0001

Size: 20g



Dosage: 0,5g/Kg

• E171 FREE

• OGM FREE

• AZO FREE

• GLUTEN FREE



WHITE

Item: 99.510.09.0001

Size: 20g

Chocolate
Cioccolato



Dosage: 10,0g/Kg



RED

Item: 99.510.06.0001

Size: 20g



Dosage: 1,6g/Kg



GREEN

Item: 99.510.07.0001

Size: 20g



Dosage: 1,6g/Kg



BLACK

Item: 99.510.08.0001

Size: 20g



Dosage: 14,0g/Kg

GEL FOOD COLOUR

COLORANTI ALIMENTARI IN GEL

Concentrated gel colouring. Ideal for colouring the surface of sugar paste, bakery product, cream and glazes.

Colorante concentrato in gel. Ideale per la colorazione in massa di: pasta di zucchero, prodotti da forno, panna e glasse.

• OGM FREE

• GLUTEN FREE

• PALM OIL FREE

• VEGAN FRIENDLY



ORANGE

Item: 99.506.01.0001
Size: 15g



LIGHT BLUE

Item: 99.506.02.0001
Size: 15g



RED

Item: 99.506.06.0001
Size: 15g



YELLOW

Item: 99.506.03.0001
Size: 15g



BLACK

Item: 99.506.04.0001
Size: 15g



PINK

Item: 99.506.05.0001
Size: 15g



GREEN

Item: 99.506.07.0001
Size: 15g



PURPLE

Item: 99.506.08.0001
Size: 15g



SUGAR PASTE

PASTA DI ZUCCHERO

White and coloured sugar paste without palm oil, available in convenient ready-to-use packs. The white sugar paste can be coloured using Gel Colours i78. Ideal for covering birthday cakes, celebration cakes and cakes for any occasion, it is also used to decorate cupcakes, cake pops and many other creations. Also ideal for modelling all kinds of decorations.

Pasta di zucchero bianca e colorata senza olio di palma, disponibile in pratiche confezioni pronte all'uso. La pasta di zucchero bianca può essere colorata con l'utilizzo di Gel Colors i78. Ideale per coprire torte di compleanno, torte da cerimonia e torte per ogni occasione, viene usata anche per decorare cupcakes, cake pops e tante altre preparazioni. Ideale inoltre per modellare ogni tipo di decorazione.

• E171 FREE

• OGM FREE

• GLUTEN FREE

• PALM OIL FREE



SUGAR PASTE 250 GR BLACK

Item: 99.501.01.0001
Size: 250g



SUGAR PASTE RED

Item: 99.501.10.0001
Size: 250g



SUGAR PASTE WHITE

Item: 99.501.12.0001
Size: 250g
Item: 99.502.01.0001
Size: 500g
Item: 99.503.01.0001
Size: 1Kg



SUGAR PASTE WHITE

+



GEL COLOR

=



COLOR YOUR SUGAR PASTE
COLORA LA TUA PASTA DI ZUCCHERO

DECORATION – FINAL TOUCHES

DECORAZIONE – ULTIMI RITOCCHI



DECORATIVE PENS

Ready-to-use food markers with fine tip for drawing or writing on sugar paste, plastic chocolate, icing sheets and wafer sheets.

Pennarelli alimentari pronti all'uso a punta fine per disegnare o scrivere su pasta di zucchero, cioccolato plastico, fogli di glassa e fogli di ostia.

Item: 99.538.01.0065

6 pens



FOGLIA ARGENTO 999/1000 80X80 MM

5 edible silver sheets 80 x 80 mm

5 fogli d'argento alimentare 80 x 80 mm

Item: 99.535.02.0001



FOGLIA ORO 23 K 80X80 MM

5 23k gold edible sheets

5 fogli oro edibile 23k

Item: 99.535.01.0001



READY LACE

GEL PER DECORAZIONI

EDIBLE GLUTENFREE GEL READY-TO-USE TO CREATE PERFECT AND ELASTIC LACES AND OTHER CAKE DECORATIONS.

GEL ALIMENTARE SENZA GLUTINE PRONTO ALL'USO PER CREARE PIZZI PERFETTI ED ELASTICI E ALTRE DECORAZIONI PER TORTE.

Ready Lace is a colorable gel for making beautiful sugar lace to decorate cakes, biscuits, etc. Extremely simple to use, it allows you to decorate cakes and desserts with a true three-dimensional effect. Available in two sizes: 140g and 520g

Ready Lace è un gel colorabile per la realizzazione di bellissimi pizzi in zucchero per decorare torte, biscotti ecc. Semplicissimo da utilizzare, permette di decorare torte e dessert attraverso un vero effetto tridimensionale. Disponibile in due formati: 140g e 520g.



READY LACE - 140 G

Item: 99.531.01.0001

Size: 140g



READY LACE - 520 G

Item: 99.531.03.0001

Size: 500g



MODO D'USO

HOW TO USE - MODE D'EMPLOI



COMMODITIES

I BASICI



NO-STICK DECOR

Food grade no-stick spray for greasing ovens, pans, moulds and hot plates.

Staccante alimentare spray per ungere teglie, stampi, forme e piastre.

Item: 99.518.99.0001
Size: 200ml



COOLER DECOR

Rapid cooling spray, to fix sugar-based products and chocolate compositions, ensuring a quick and instant set. With straw, ideal for sugar and chocolate.

Raffreddante rapido in spray, per fissare prodotti a base di zucchero e composizioni di cioccolato, garantendo una presa rapida ed istantanea. Con cannucchia, ideale per zucchero e cioccolato.

Item: 99.517.99.0001
Size: 400ml





SCIROPPO DI GLUCOSIO

Thick liquid, gives elasticity to the sugar paste, plastic chocolate, fondant. It is also used for candies and sweets.

Liquido denso, conferisce elasticità alla pasta di zucchero, cioccolato plastico, fondant. Viene utilizzato anche per le caramelle.

Item: 99.531.02.0001
Size: 230g



ISOMALTO

Isomalt is a natural substitute for sugar, which is mainly used for its physical characteristics similar to those of sugar. Isomalt is a disaccharide composed of two sugars glucose and mannitol. The isomalt can be dissolved either in the microwave or in a pan with double bottom. Isomalt is transparent (this differs from caramel) then you can either leave it as is or colour it (put the gel colour before it is dissolved). The flavour is equal to that of regular sugar. It cools more slowly than caramel and you have a little more time to shape the decorations.

L'isomalto è un sostituto naturale dello zucchero. Si tratta di un disaccaride composto dai due zuccheri glucosio e mannitolo. L'isomalto non ha l'indesiderato "effetto di raffreddamento" (cooling effect) proprio di altri zuccheri alcolici. Può essere utilizzato anche per la scultura di zucchero ed alcuni lo preferiscono in quanto cristallizza più lentamente. È trasparente (in questo differisce dal caramello) quindi potete lasciarlo così o colorarlo (aggiungendo dei coloranti in gel prima di scioglierlo). Il sapore è uguale a quello del normale zucchero. Raffreddandosi più lentamente del caramello, si ha un po' più di tempo per modellare le decorazioni.

Item: 99.527.01.0001
Size: 500g



FLAVOURING PASTE

PASTA CONCENTRATA

Highly concentrated flavoring pastes to add to creams, doughs and ice creams, also excellent for baking. A few grams are enough to add the chosen aroma to your preparations. Extremely simple to use, they guarantee a professional result and are perfect to use with The One Mirror Glaze, and Cake Mix.

Paste aromatizzanti altamente concentrate da aggiungere a creme, impasti e gelati, ottime anche in cottura. Bastano pochi grammi per aggiungere l'aroma scelto alle vostre preparazioni. Semplicissime da usare, garantiscono un risultato professionale e sono perfette da usare con The One Mirror Glaze, e Cake Mix.



PISTACHIO 99%

PASTA AROMATIZZANTE PISTACCHIO 99%

Item: 99.525.03.0001

Size: 150g



HAZELNUT 100%

PÂTE AROMATISÉE - NOISETTE 100%

Item: 99.525.01.0001

Size: 150g



GIANDUJA

PASTA AROMATIZZANTE GIANDUJA

Item: 99.525.02.0001

Size: 150g



VANILLA

PASTA AROMATIZZANTE ALLA VANIGLIA

Item: 99.525.04.0001

Size: 150g



LEMON 100%

PASTA AROMATIZZANTE LIMONE

Item: 99.525.07.0001

Size: 150g



STRAWBERRY

PASTA AROMATIZZANTE FRAGOLA

Item: 99.525.06.0001

Size: 150g



TIRAMISÙ

PASTA AROMATIZZANTE TIRAMISÙ

Item: 99.525.08.0001

Size: 150g



CARAMEL

PASTA AROMATIZZANTE CARAMELLO SALATO

Item: 99.525.06.0001

Size: 150g



THE I78 CAKE MIXES

I PREPARATI



- Easy to use
- High quality ingredients
- Made in Italy
- Clear instructions
- Easy gluten free at home
- No special equipment needed
- Time saving
- No baking experience needed
- Wide choice
- Translation in 6 languages
- Suitable for the whole family

- *Facile da usare*
- *Ingredienti di alta qualità*
- *Made in Italy*
- *Istruzioni chiare*
- *Facile senza glutine a casa*
- *Nessuna attrezzatura speciale necessaria*
- *Fa risparmiare tempo*
- *Nessuna esperienza di cottura necessaria*
- *Ampia scelta*
- *Traduzione in 6 lingue*
- *Adatto a tutta la famiglia*





BROWNIES - 400G

Item: 99.504.11.0062

Size: 400g

Powder Mix for BROWNIES

Preparato in polvere per BROWNIES



CREMA AL BURRO

Item: 99.504.25.0062

Size: 200g

Powder mix for BUTTER CREAM

Preparato in polvere per CREMA AL BURRO



FROSTING ALLA VANIGLIA

Item: 99.504.15.0062

Size: 200g

Powder mix for FROSTING

Preparato in polvere per FROSTING





GHIACCIA REALE

Item: 99.504.16.0062

Size: 200g

Powder mix for ROYAL ICING
Preparato in polvere per GHIACCIA REALE



MACARON - BIANCO

Item: 99.504.14.0062

Size: 200g

Powder mix for MACARONS - WHITE
Preparato in polvere per MACARON



RED VELVET

Item: 99.504.12.0062

Size: 400g

Powder mix for RED VELVET CAKE
preparato in polvere per RED VELVET



MUFFIN & CUPCAKE AL CACAO

Item: 99.504.24.0062

Size: 400g

Powder mix for MUFFIN & CUPCAKES

Preparato in polvere per MUFFIN & CUPCAKE



PAN DI ZENZERO

Item: 99.504.13.0062

Size: 400g

POWDER MIX FOR GINGERBREAD COOKIES

Preparato in polvere per PAN DI ZENZERO



TORTA AL CACAO

Item: 99.504.23.0062

Size: 400g

Powder Mix for COCOA CAKE

Preparato in polvere per TORTA AL CACAO



TORTA ALLE MELE E CANNELLA

Item: 99.504.26.0062

Size: 400g



Powder Mix for APPLE AND CINNAMON CAKE
*preparato in polvere per TORTA MELA
E CANNELLA*



MOUSSE

Item: 99.504.05.0062

Size: 200g



Powder Mix for MOUSSE
Preparato in polvere per MOUSSE



PAN DI SPAGNA

Item: 99.504.06.0062

Size: 400g





TORTA VANIGLIA

Item: 99.504.09.0062

Size: 400g

Powder mix for VANILLA FLAVORED CAKE
Preparato in polvere per TORTA VANIGLIA



CREMA PASTICCERA

Item: 99.504.02.0062

Size: 200g

Powder mix for CUSTARD CREAM
Preparato in polvere per CREMA PASTICCERA



CUPCAKE & MUFFIN

Item: 99.504.03.0062

Size: 400g

Powder mix for CUPCAKE & MUFFIN
Preparato in polvere per CUPCAKE & MUFFIN



FROLLA & BISCOTTI

Item: 99.504.04.0062

Size: 400g

Powder mix for shortcrust PASTRY AND COOKIES

Preparato in polvere per FROLLA & BISCOTTI



WAFFLE & PANCAKES

Item: 99.504.07.0062

Size: 200g

Powder mix for PANCAKE & WAFFLE

Preparato in polvere per PANCAKE & WAFFLE



TORTA ALLE MANDORLE E CAROTE

Item: 99.504.08.0062

Size: 400g

Powder mix for ALMOND AND CARROT* CAKE

*Preparato in polvere per TORTA ALLA MANDORLE E CAROTE**



*Fresh ingredient to add, not included in the package.

*ingrediente fresco da aggiungere, non contenuto nella confezione.

ITEM	PALM OIL FREE	AZO FREE	E171 FREE	OGM FREE	GLUTEN FREE	VEGAN FRIENDLY
BROWNIES	●	●	●	●	●	
CREMA AL BURRO	●	●	●	●	●	
FROSTING ALLA VANIGLIA		●	●	●	●	
GHIACCIA REALE	●	●	●	●	●	●
MACARON BIANCO	●	●	●	●	●	
RED VELVET	●	●	●	●	●	
MUFFIN & CUPCAKE CACAO	●	●	●	●	●	
PAN DI ZENZERO	●	●	●	●	●	
TORTA AL CACAO	●	●	●	●	●	
TORTA MELE CANNELLA	●	●	●	●	●	
MOUSSE	●	●	●	●	●	
PAN DI SPAGNA	●	●	●	●	●	
TORTA VANIGLIA	●	●	●	●	●	
CREMA PASTICCERA	●	●	●	●	●	●
CUPCAKES & MUFFIN	●	●	●	●	●	
FROLLA & BISCOTTI	●	●	●	●	●	
WAFFLE & PANCAKES	●	●	●	●	●	
TORTA MANDORLE E CAROTE	●	●	●	●	●	



RAINBOW CAKE

TORTA ARCOBALENO

The rainbow cake is a very colourful layer cake, truly spectacular, in which every layer has a different colour to create a rainbow filled with delicious cream. The i78 by Silikomart powder mixes for rainbow cake are designed to allow maximum customization of the dessert: choose the colours individually and combine them as you wish thanks to the practical single 100-gram packs. Each pack of powdered food preparation is designed for making a Ø 22/24 cm layer of rainbow.

Rainbow cake, è una torta a piani coloratissima, davvero spettacolare in cui ogni strato ha un colore diverso fino a creare un arcobaleno farcito di golosa crema. I preparati in polvere i78 by Silikomart per rainbow cake sono pensati per permettere la massima personalizzazione del dolce: scegli singolarmente i colori e combinali come vuoi tu grazie alle pratiche confezioni singole da 100 grammi. Ogni confezione di preparato alimentare in polvere è pensato per la realizzazione di uno strato di torta rainbow cake del diametro di 22/24 cm.

Powder Mix for RAINBOW CAKE

Preparato per in polvere per
RAINBOW CAKE



RAINBOW CAKE - VERDE

Item: 99.504.21.0062
Size: 100g



RAINBOW CAKE - ARANCIO

Item: 99.504.22.0062
Size: 100g



RAINBOW CAKE - BLU

Item: 99.504.19.0062
Size: 100g



RAINBOW CAKE - GIALLO

Item: 99.504.20.0062
Size: 100g



RAINBOW CAKE - ROSSO

Item: 99.504.17.0062
Size: 100g



RAINBOW CAKE - VIOLA

Item: 99.504.18.0062
Size: 100g

