



PRIMA COLLECTION

**2026**



# INDICE

## INDEX

### POSATE / CUTLERY

Bell.....	15
Country.....	30
Daisy.....	28
Derby.....	11
Dinner.....	14
Dover.....	19
Drop.....	36
Drop Satin.....	38
Duke Satin.....	32
Easy.....	7
Eat.....	20
Flavia.....	10
Galles.....	16
Lunch.....	4
Marina.....	12
Marina Vibrato.....	8
Milano.....	17
Monaco.....	13
Nice.....	3
Ponza.....	24
Princess.....	34
Sea.....	6
Venezia.....	18
Versilia.....	9
Villa.....	22
Villa Satin.....	23
Accessori/Accessories.....	41
Confezioni posate / Cutlery packaging.....	27
Prima set oliere / Cruet set .....	42
Set coltelli / Knives set.....	40

### COTTURA / COOKWARE

Comfort.....	52
Cook-it.....	61
Ecoline.....	46
First.....	54
First pent. pressione / Pressure cooker.....	55
Inox Plus.....	50
Pop .....	58
Pop Extra.....	60
Portofino.....	65
Smart set padelle / Frying pan set.....	64
Tender Alu Easy .....	56
X-Black .....	62

### GASTRONORM

GN-P.....	67
-----------	----

### UTENSILI DA CUCINA / KITCHEN TOOLS

Gadget Fast.....	71
Gadget FPR.....	74
Smart.....	78



# NICE

## 004

18/0





mm 1,5



SOLO VENDITA MASTER  
ONLY MASTER SELLING



Chiave  
(master pcs 24)

		<b>cod. chiave</b>	<b>cm cutlery</b>
x3		<b>AW301</b>	19,0
x3		<b>AW302</b>	19,0
x2		<b>AW2L3</b>	21,5
x4		<b>AW407</b>	14,0
x4		<b>AW417</b>	14,0

# LUNCH

## 296

18/0

UDV 12 pz

mm 1,8

Confezione 12 pz / 12 pcs box

cod.



00001



00002



000L3



000F3



000F7



00007



00017





# SEA R02

18/0  
UDV 120 pz  
mm 1,5

Set posate / Cutlery set

**cod.** set

**0E2SN** 16 pcs

**0E291** 24 pcs

**SOLO VENDITA MASTER  
ONLY MASTER SELLING**

Master pcs 120

**cod.  
master**

 **0M001**

 **0M002**

 **0M0L3**

 **0M007**



**SOLO VENDITA MASTER  
ONLY MASTER SELLING**



Chiave  
(master pcs 24)

**cod.  
chiave** cm  
cutlery

x3  **HW301** 19,7

x3  **HW302** 20,0

x2  **HW2L3** 21,3

x6  **HW607** 13,0

# EASY

## 124

18/0

UDV 12 pz





mm 1,5



Set posate / Cutlery set

cod.	set
0E2SN	16 pcs
0E291	24 pcs





Confezione 12 pz / 12 pcs box

	cod.
	00001
	00002
	000L3
	00007
	00017

SOLO VENDITA MASTER  
ONLY MASTER SELLING



Valva  
(master pcs 10)





	cod. valva
x24 	0\$Q01
x24 	0\$Q02
x12 	0\$HL3*
x36 	0\$B07
x36 	0\$B17

\*lamin. 3,8 mm

SOLO VENDITA MASTER  
ONLY MASTER SELLING



Chiave  
(master pcs 24)

	cod. chiave	cm cutlery
x3 	EW301	19,0
x3 	EW302	19,0
x2 	EW2L3	20,9
x6 	EW607	13,7
x6 	EW417	13,6

# MARINA VIBRATO

## 117

18/0

UDV 240 pz

mm 1,8

Set posate / Cutlery set

cod. set







1E2SN 16 pcs

1E291 24 pcs

**SOLO VENDITA MASTER  
ONLY MASTER SELLING**

Master pcs 240

cod.  
master

	<b>1M001</b>
	<b>1M002</b>
	<b>1M0L3</b>
	<b>1M004</b>
	<b>1M005</b>
	<b>1M007</b>
	<b>1M008</b>



**SOLO VENDITA MASTER  
ONLY MASTER SELLING**



Chiave  
(master pcs 24)

	cod. chiave	cm cutlery
x3	<b>KW301</b>	19,7
x3	<b>KW302</b>	20,0
x2	<b>KW2L3</b>	21,0
x3	<b>KW304</b>	18,5
x3	<b>KW305</b>	18,7
x6	<b>KW607</b>	13,0
x6	<b>KW608</b>	11,2

# VERSILIA

## 102

18/0





UDV 12 pz

mm 1,5

Set posate / Cutlery set

<b>cod.</b>	<b>set</b>
<b>0E2SN</b>	16 pcs
<b>0E291</b>	24 pcs

Confezione 12 pz / 12 pcs box





	<b>cod.</b>
	<b>00001</b>
	<b>00002</b>
	<b>000L3</b>
	<b>00007</b>



SOLO VENDITA MASTER  
ONLY MASTER SELLING



Chiave  
(master pcs 24)

	<b>cod. chiave</b>	<b>cm cutlery</b>
x3 	<b>EW301</b>	19,7
x3 	<b>EW302</b>	19,2
x2 	<b>EW2L3</b>	22,0
x6 	<b>EW607</b>	12,5

# FLAVIA

## 109

18/0

UDV 12 pz

mm 1,5

Set posate / Cutlery set

**cod.** set

**0E2SN** 16 pcs

**0E291** 24 pcs

Confezione 12 pz / 12 pcs box

**cod.**

 **00001**

 **00002**

 **000L3**

 **00007**



SOLO VENDITA MASTER  
ONLY MASTER SELLING



Chiave  
(master pcs 24)

**cod.** cm  
**chiave** cutlery

x3  **EW301** 19,5

x3  **EW302** 19,5

x2  **EW2L3** 22,2

x6  **EW607** 12,5

# DERBY R03

18/0

UDV 120 pz

mm 2,0

Set posate / Cutlery set

**cod.** set









**0E2SN** 16 pcs

**0E291** 24 pcs

**SOLO VENDITA MASTER  
ONLY MASTER SELLING**

Master pcs 120

**cod.  
master**

	<b>0M001</b>
	<b>0M002</b>
	<b>0M0L3</b>
	<b>0M0F3</b>
	<b>0M004</b>
	<b>0M005</b>
	<b>0M0L6</b>
	<b>0M007</b>
	<b>0M008</b>











**SOLO VENDITA MASTER  
ONLY MASTER SELLING**



Chiave

(master pcs 24)

**cod. chiave** cm cutlery

x3		<b>FW301</b>	19,6
x3		<b>FW302</b>	19,6
x2		<b>FW2L3</b>	22,0
x3		<b>FW304</b>	17,8
x3		<b>FW305</b>	17,7
x2		<b>FW2L6</b>	19,4
x6		<b>FW607</b>	14,1
x6		<b>FW608</b>	11,5

# MARINA

## 117

18/0

UDV 240 pz

mm 1,8

Set posate / Cutlery set

**cod.** set









**0E2SN** 16 pcs

**0E291** 24 pcs

**SOLO VENDITA MASTER  
ONLY MASTER SELLING**

Master pcs 240

**cod.  
master**









	<b>0M001</b>
	<b>0M002</b>
	<b>0M0L3</b>
	<b>0M004</b>
	<b>0M005</b>
	<b>0M007</b>
	<b>0M008</b>
	<b>0M017</b>



**SOLO VENDITA MASTER  
ONLY MASTER SELLING**



Chiave  
(master pcs 24)

	<b>cod. chiave</b>	cm cutlery
x3	 <b>HW301</b>	19,7
x3	 <b>HW302</b>	20,0
x2	 <b>HW2L3</b>	21,0
x3	 <b>HW304</b>	18,5
x3	 <b>HW305</b>	18,7
x6	 <b>HW607</b>	13,0
x6	 <b>HW608</b>	11,2
x6	 <b>HW617</b>	14,7

# MONACO

## 174

18/0

UDV 120 pz

mm 1,8

Set posate / Cutlery set

**cod.** set











**0E2SN** 16 pcs

**0E291** 24 pcs

**SOLO VENDITA MASTER  
ONLY MASTER SELLING**

Master pcs 120













	<b>cod. master</b>
	<b>0M001</b>
	<b>0M002</b>
	<b>0M0L3</b>
	<b>0M004</b>
	<b>0M005</b>
	<b>0M0L6</b>
	<b>0M007</b>
	<b>0M008</b>
	<b>0M017</b>
	<b>0M036</b>

**SOLO VENDITA MASTER  
ONLY MASTER SELLING**



Chiave  
(master pcs 24)

	<b>cod. chiave</b>	<b>cm cutlery</b>
x3 	<b>GW301</b>	19,6
x3 	<b>GW302</b>	19,6
x2 	<b>GW2L3</b>	20,8
x3 	<b>GW304</b>	18,5
x3 	<b>GW305</b>	18,5
x2 	<b>GW2L6</b>	19,7
x6 	<b>GW607</b>	13,0
x6 	<b>GW608</b>	11,3
x6 	<b>GW617</b>	15,0
x6 	<b>GW636</b>	21,0

# DINNER R04

18/0  
UDV 120 pz  
mm 2,0

Set posate / Cutlery set

**cod.** set







**0E2SN** 16 pcs

**0E291** 24 pcs

**SOLO VENDITA MASTER  
ONLY MASTER SELLING**

Master pcs 120

**cod.  
master**

	<b>0M001</b>
	<b>0M002</b>
	<b>0M0L3</b>
	<b>0M0F3</b>
	<b>0M0F7</b>
	<b>0M007</b>







**SOLO VENDITA MASTER  
ONLY MASTER SELLING**



Chiave  
(master pcs 24)

**cod.  
chiave** cm  
cutlery

x3		<b>HW301</b> 20,0
x3		<b>HW302</b> 20,0
x2		<b>HW2L3</b> 22,0
x6		<b>HW607</b> 14,2

# BELL 144

18/0

UDV 120 pz

mm 1,5

Set posate / Cutlery set

**cod.** set





**0E2SN** 16 pcs

**0E291** 24 pcs

**SOLO VENDITA MASTER  
ONLY MASTER SELLING**

Master pcs 120

**cod.  
master**

-  **0M001**
-  **0M002**
-  **0M0L3**
-  **0M007**







**SOLO VENDITA MASTER  
ONLY MASTER SELLING**



Chiave  
(master pcs 24)

**cod. chiave** cm cutlery

- x3**  **FW301** 19,6
- x3**  **FW302** 19,5
- x2**  **FW2L3** 21,3
- x6**  **FW607** 14,0

# GALLES

## 089

18/10

UDV 12 pz

mm 1,8



Set posate / Cutlery set

**cod.** set

**XE2SN** 16 pcs

**XE291** 24 pcs

Confezione 12 pz / 12 pcs box

**cod.**

 **X0001**

 **X0002**

 **X00L3**

 **X00F3**

 **X0005**

 **X00L6**

 **X0007**

 **X0008**

 **X0017**

Sfuso / Single pieces

**cod.** cm  
cutlery

 **X0010** 26,8

 **X0011** 21,8

 **X0012** 21,6

 **X0020** 23,4

SOLO VENDITA MASTER  
ONLY MASTER SELLING



Chiave  
(master pcs 24)

**cod.** cm  
**chiave** cutlery

x3  **GW301** 21,0

x3  **GW302** 21,0

x2  **GW2L3** 22,0

x3  **GW305** 17,6

x2  **GW2L6** 19,6

x6  **GW607** 15,2

x6  **GW608** 11,6

x6  **GW617** 15,2

# MILANO

## R10

18/10

UDV 120 pz

mm 2,2

Set posate / Cutlery set

**cod.** set

**0E2SN** 16 pcs

**0E291** 24 pcs

**SOLO VENDITA MASTER  
ONLY MASTER SELLING**

Master pcs 120

**cod.  
master**

 **0M001**

 **0M002**

 **0M0L3**

 **0M007**





**SOLO VENDITA MASTER  
ONLY MASTER SELLING**





Chiave  
(master pcs 24)

**cod. cm**  
**chiave cutlery**

x3  **CW301** 19,5

x3  **CW302** 19,5

x2  **CW2L3** 21,5

x6  **CW607** 14,0

# VENEZIA

## R08

18/10

UDV 120 pz

mm 2,2

Set posate / Cutlery set

**cod.** set

**0E2SN** 16 pcs

**0E291** 24 pcs

**SOLO VENDITA MASTER  
ONLY MASTER SELLING**

Master pcs 120

**cod.  
master**

 **0M001**

 **0M002**

 **0M0L3**

 **0M007**



**SOLO VENDITA MASTER  
ONLY MASTER SELLING**



Chiave  
(master pcs 24)

**cod. cm  
chiave cutlery**

x3  **CW301** 19,5

x3  **CW302** 19,5

x2  **CW2L3** 21,5

x6  **CW607** 13,3

# DOVER R11

18/0

UDV 120 pz

mm 2,5

Set posate / Cutlery set

**cod.** set

**0E0SN** 16 pcs

**0E091** 24 pcs

**SOLO VENDITA MASTER  
ONLY MASTER SELLING**

Master pcs 120

**cod.  
master**











	<b>0M001</b>
	<b>0M002</b>
	<b>0M003</b>
	<b>0M0F3</b>
	<b>0M067</b>
	<b>0M004</b>
	<b>0M005</b>
	<b>0M006</b>
	<b>0M007</b>
	<b>0M008</b>
	<b>0M017</b>
	<b>0M036</b>

**SOLO VENDITA MASTER  
ONLY MASTER SELLING**



Chiave  
(master pcs 24)

**cod. chiave** cm cutlery

x3		<b>BW301</b> 20,2
x3		<b>BW302</b> 20,5
x2		<b>BW203</b> 23,5
x2		<b>BW267</b> 22,5
x3		<b>BW304</b> 17,8
x3		<b>BW305</b> 17,7
x2		<b>BW206</b> 21,5
x6		<b>BW607</b> 14,0
x6		<b>BW608</b> 12,2
x6		<b>BW617</b> 15,1
x6		<b>BW636</b> 21,0

# EAT 257









18/10  
UDV 12 pz  
mm 1,8



Set posate / Cutlery set

cod.	set
0E0SN	16 pcs
0E091	24 pcs







Confezione 12 pz / 12 pcs box

	cod.
	00001
	00002
	00003
	00007
	00008
	00017
	00067
	00051

SOLO VENDITA MASTER  
ONLY MASTER SELLING









Valva  
(master pcs 10)

		cod. valva
x12		0\$H01
x12		0\$H02
x6		0\$603
x20		0\$U07
x18		0\$\$17
x6		0\$651

SOLO VENDITA MASTER  
ONLY MASTER SELLING



Chiave  
(master pcs 24)

		cod. chiave	cm cutlery
x3		LW301	20,1
x3		LW302	19,9
x2		LW203	21,8
x6		LW607	14,2
x6		LW608	11,5
x6		LW617	15,5



# VILLA 255

18/10  
UDV 12 pz  
mm 2,5

Set posate / Cutlery set

cod.	set
0E0SN	16 pcs
0E091	24 pcs

Confezione 12 pz / 12 pcs box



	cod.
	00001
	00002
	00003
	000F3
	000F7
	00004
	00005
	00006
	000F6
	00007
	00008
	00017
	00029

SOLO VENDITA MASTER  
ONLY MASTER SELLING



Chiave  
(master pcs 24)

	cod. chiave	cm cutlery
x3	CW301	20,9
x3	CW302	20,8
x2	CW203	23,0
x3	CW304	18,0
x3	CW305	18,0
x2	CW206	21,0
x6	CW607	14,5
x6	CW608	11,1
x6	CW617	15,6
x3	CW329	20,0

# VILLA SATIN

## 255

18/10

UDV 12 pz

mm 2,5



Set posate / Cutlery set

**cod.** set

**UE0SN** 16 pcs

**UE091** 24 pcs

Confezione 12 pz / 12 pcs box

**cod.**

 **U0001**

 **U0002**

 **U0003**

 **U0004**

 **U0005**

 **U0006**

 **U0007**

 **U0008**

 **U0017**

 **U0029**

# PONZA

## 256

18/10

UDV 12 pz

mm 2,5



Set posate / Cutlery set

cod. set

0E0SN 16 pcs

0E091 24 pcs

Confezione 12 pz / 12 pcs box

cod.

 00001

 00002

 00003

 00004

 00005

 00006

 00007

 00008

 00017

 00029

Sfuso / Single pieces

cod.

 00010

 00011

 00012

 00013

SOLO VENDITA MASTER  
ONLY MASTER SELLING



Chiave  
(master pcs 24)

cod. cm  
chiave cutlery

x3  **GW301** 20,3

x3  **GW302** 20,1

x2  **GW203** 22,8

x3  **GW304** 18,0

x3  **GW305** 18,0

x2  **GW206** 21,0

x6  **GW607** 14,0

x6  **GW608** 11,7

x6  **GW617** 15,4

x3  **GW329** 20,5



**CONFEZIONI**  
PACKAGING

# CONFEZIONI POSATE CUTLERY PACKAGING

Ecobox 16/24 pz  
Ecobox 16/24 pcs  
**cod. 92032020**



Confezione 12 pz  
Box 12 pcs

<b>cod.</b>	descriz.
<b>90515000</b>	confezione grande <i>large box</i>
<b>90515001</b>	confezione piccola <i>small box</i>



# DAISY

## 2G\_07091

18/0 + ABS  
SET 24 PCS



cod. colour

A   
BLACK

B   
WHITE

C   
BLUE

D   
SAND

E   
GREEN

F   
RED





# COUNTRY

## 2F\_07091

18/0 + ABS

SET 24 PCS



cod. colour

A  WOOD

B  BLACK

C  GREY

D  GREEN





# DUKE SATIN

## 2K\_U7091

18/0

SET 24 PCS

mm 3,0

cod. colour

O



STEEL

R



SUN

S



AMBER

T



CARBON



Confezione 12 pz  
12 pcs box

cod. colour

2KRU0001

2KRU0002

2KRU0003

2KRU0007

2KSU0001

2KSU0002

2KSU0003

2KSU0007

2KTU0001

2KTU0002

2KTU0003

2KTU0007



SUN



AMBER



CARBON





# PRINCESS

## 2C\_07091

18/0

SET 24 PCS

mm 3,0



cod. colour

0



STEEL

R



SUN

S



AMBER

T



CARBON

U\*



RAINBOW

\* In esaurimento / Discontinued



Confezione 12 pz  
12 pcs box

cod. colour

2CR00001

2CR00002

2CR00003

2CR00007

2CS00001

2CS00002

2CS00003

2CS00007

2CT00001

2CT00002

2CT00003

2CT00007



SUN



AMBER



CARBON





# DROP

## 28500091



18/0

SET 24 PCS

mm 2,0

*design Marcello Ziliani*





# DROP SATIN

## 28\_U0091



18/0

SET 24 PCS

mm 2,0

design Marcello Ziliani

cod. colour

5



STEEL

R



SUN

T



CARBON





# SET COLTELLI

## KNIVES SET

Coltello pizza (cm 20,5)

*Pizza knife*

**cod. 74600...**



cod.    descriz.

P51    scatola bianca 12 pz / 12 pcs set white box

651    blister 6 pz / blister 6 pcs



Coltello tavola (cm 21,7)

*Table knife*

**cod. 74600...**

cod.    descriz.

PEK    scatola bianca 12 pz / 12 pcs set white box

6EK    blister 6 pz / blister 6 pcs



Coltello bistecca (cm 22,2)

*Steak knife*

**cod. 74600...**

cod.    descriz.

PEU    scatola bianca 12 pz / 12 pcs set white box

6EU    blister 6 pz / blister 6 pcs



Coltello bistecca punta tonda (cm 22,2)

*Steak knife rounded tip*

**cod. 74600...**

cod.    descriz.

PFU    scatola bianca 12 pz / 12 pcs set white box

6FU    blister 6 pz / blister 6 pcs



Coltello bistecca con manico effetto legno (cm 22,2)  
*Steak knife with wooden handle effect*  
**cod. 7460L...**

cod.	descriz.
PEU	scatola bianca 12 pz / 12 pcs set white box
6EU	blister 6 pz / blister 6 pcs



Coltello bistecca punta tonda con manico effetto legno (cm 22,2)  
*Steak knife rounded tip with wooden handle effect*  
**cod. 7460L...**

cod.	descriz.
PFU	scatola bianca 12 pz / 12 pcs set white box
6FU	blister 6 pz / blister 6 pcs



## ACCESSORI ACCESSORIES

Forbice da cucina  
*Kitchen scissor*  
**cod. 58174620**



Cavatappi  
*Corkscrew*  
**cod. 50916200**



Cavatappi professionale  
*Professional corkscrew*  
**cod. 58174300**



# OLIERE PRIMA

## 5717

18/0 + vetro/glass

Sistema salvagoccia

Non-leaking system

Articoli venduti in scatola litografata

Articles are packed in lithographed box



Set oliera 5 posti / 5 pcs cruet set

**cod. 57175205**

ml                  cm

175 / 35      14x11x20



Set sale, pepe e stuzzicadenti / Salt, pepper and toothpick set

**cod. 57177303**

ml                  cm

35              10x8,3x11,5



Formaggera / Cheese bowl

**cod. 57173000**

ml                  cm

200            11x10x12,5



## RICAMBI / SPARE PARTS

**cod. 97200151** vetro per olio e aceto / oil and vinegar glass

**cod. 97200152** vetro per sale e pepe / salt and pepper glass

**cod. 97200153** vetro per stuzzicadenti / toothpick glass

**cod. 97200150** vetro per formaggera / cheese bowl glass

**cod. 97200154** tappo per olio / cup for oil and vinegar glass

**cod. 97200155** tappo per sale e pepe / salt and pepper glass



**COTTURA**  
COOKWARE

INOX  
18/0

## ECOLINE R500



MANICO IN ACCIAIO

STAINLESS STEEL HANDLE



INOX  
18/0

## INOX PLUS R600



MANICO IN ACCIAIO CON FONDO  
TERMODIFFUSORE

STAINLESS STEEL HANDLE WITH  
THERMAL DIFFUSION BOTTOM



INOX  
18/0

## COMFORT R650



MANICO IN BACHELITE CON  
FONDO TERMODIFFUSORE

BAKELITE HANDLE WITH  
THERMAL-DIFFUSION BOTTOM



PRIMA COLLECTION

**LE SERIE DI  
PENTOLAME  
IN ACCIAIO  
MADE IN  
ITALY**

**MADE IN  
ITALY  
STAINLESS  
STEEL  
COOKWARE**

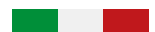

*Nickel Free  
family*

1. Tutti gli articoli sono prodotti in Italia.
2. Tre serie complete:  
**ECOLINE:** il miglior prezzo.  
**COMFORT:** serie elegante con manici in bachelite.  
**INOX PLUS:** ottimo rapporto qualità-prezzo.
3. Tutti gli articoli sono prodotti con acciai certificati e idonei al contatto alimentare secondo decreto legislativo DL 108 dt 25.01.92 e Dir. CEE 1935/2004 e 89/109.
4. Adatta a tutti i tipi di cucina, induzione compresa.
5. Bordo rinforzato.
6. Le maniglie e i manici sono ergonomici e in bachelite anticalore.
7. Packaging informativo dedicato.
8. Nickel Free.

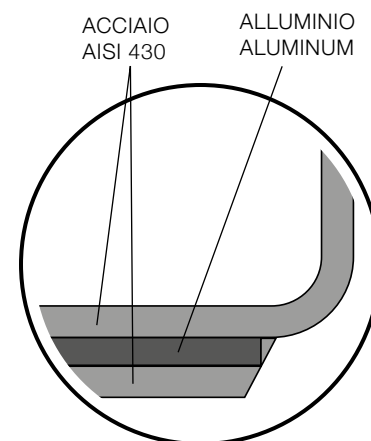

Fondo termodiffusore  
*Thermal diffusion  
 bottom*

1. 100% Made in Italy.
2. Three complete series.  
**ECOLINE:** best value for money of the series.  
**COMFORT:** Elegance series with Bakelite handles.  
**INOX PLUS:** excellent price-quality ratio.
3. All stainless steel used in mass production is in conformity with DL 108 dated 25.01.92 & CEE 1935/2004 and 89/109 law.
4. Suitable for all kind of cooktops, including induction.
5. Reinforced edge.
6. Bakelite ergonomic handles and knobs, made to avoid heat contact.
7. Nice and dedicated packaging.
8. Nickel Free.



Maniglia in bachelite  
*Bakelite handles*



Bordo rinforzato  
*Reinforced edge*

# ECOLINE R500

18/0

Made in Italy 

NICKEL  
FREE



INDUZIONE  
INDUCTION



GAS  
GAS



CERAMICO  
CERAMIC



ALOGENO  
HALOGEN



ELETTRICO  
ELECTRIC

## Pentola / Pot cod. R50003..

Ø cm	h cm	Lt	Master	cm Master	kg Master
16	12	2,1	6	30x20x46	2,76
18	13	2,8	6	31x33,5x45	3,23
20	14,5	3,8	6	31x34x46	2,76
22	14,7	5	4	33x32,5x44	2,86
24	17,1	6,5	4	38x30x55	3,28
26	17,3	8,5	4	37x29x57	3,81
28	18	10,5	2	37x29x57	2,96



## Casseruola / Casserole cod. R50005..

Ø cm	h cm	Lt	Master	cm Master	kg Master
16	7,5	1,3	6	24x34x23	2,53
18	8	1,8	6	24x34x23	2,54
20	9,4	2,4	6	20x30x46	2,85
22	10,5	3,5	4	46x30x18	2,40
24	11,4	4,8	4	33x30x34	2,70
26	13	5,4	4	33x30x33	2,95
28	14	8	4	37x29x57	4,06



## Tegame / Roasting pan cod. R50023..

Ø cm	h cm	Lt	Master	cm Master	kg Master
24	4,5	2	6	24x34x23	3,28
28	5	3,2	6	32x32x30	3,76



Cuoci asparagi / *Asparagus pot*  
**cod. R5000816**

Ø cm	h cm	Lt
16	20,5	4



Casseruola ovale con coperchio / *Oval casserole with lid*  
**cod. R50016..**

cm	h cm	Lt
28	9,5	3,6
32	11	5,8



Colabrodo / *Colander*  
**cod. R50067..**

cm
14
16



Teglia rettangolare / *Rectangular roasting pan*  
**cod. R50004..**

cm	h cm	Lt
25x18	5	2
30x22	5,5	3,4
35x26	6	5
40x28	6,2	6,5
45x32	7,9	10



Coperchio per teglia rettangolare / *Lid for rectangular roasting pan*  
**cod. R50028..**

cm
25x18
30x22
35x26
40x28



Bollilatte / *Milkpot*  
**cod. R5006012**

Ø cm	h cm	Lt	Master	cm Master	kg Master
12	9	0,9	6	16x27x22	1,4



Cuoci Prima / *Cuoci Prima pot*

**cod. R5087720**

Ø cm	h cm	Lt
20	12,4	3,7

In esaurimento / Discontinued



Casseruola 1 manico / *Saucepan*

**cod. R50006..**

Ø cm	h cm	Lt	Master	cm Master	kg Master
12	5	0,5	6	24x13x28	1,01
16	7,5	1,3	6	23x23x34	1,74



Padella / *Frying pan*

**cod. R50025..**

Ø cm	h cm	Lt	Master	cm Master	kg Master
24	4,5	2	12	46x30x18	5,68
28	5	3,2	6	30x44,5x32,5	3,50



Cestello vapore / *Steaming basket*

**cod. R5009822**

Ø cm	h cm	Master	cm Master	kg Master
22	10,5	4	31x20x46	2,33



Coperchio / *Lid*

**cod. R50030..**

Ø cm	Master	cm Master	kg Master
16	12	26x23x33,5	1,8
18	12	26x23x36	2,11
20	12	31x20x46	2,41
22	12	31x20x46	2,94
24	12	31,5x33,5x45	3,72
26	12	31x34x45,5	4,24
28	12	31x34x45,5	5,22





# INOX PLUS R600

18/0

Con fondo termodiffusore.  
With thermal diffusion bottom.

Made in Italy 

NICKEL  
FREE



INDUZIONE  
INDUCTION



GAS  
GAS



CERAMICO  
CERAMIC



ALOGENO  
HALOGEN



ELETTRICO  
ELECTRIC

## Pentola / Pot cod. R60003..

Ø cm	h cm	Lt
16	12	2,1
18	13	2,8
20	14,5	3,8
22	14,7	5
24	17,1	6,5
26	17,3	8,5
28	18	10,5



## Casseruola / Casserole cod. R60005..

Ø cm	h cm	Lt
16	7,5	1,3
18	8	1,8
20	9,4	2,4
22	10,5	3,5
24	11,4	4,8
26	13	5,4
28	14	8



## Tegame / Roasting pan cod. R60023..

Ø cm	h cm	Lt
24	4,5	2
28	5	3,2



## Casseruola 1 manico / Saucepan cod. R60006..

Ø cm	h cm	Lt
12	5	0,5
16	7,5	1,3



Bollilatte / *Milkpot*

**cod. R6006012**

Ø cm	h cm	Lt
12	9	0,9



Padella / *Frying pan*

**cod. R60025..**

Ø cm	h cm	Lt
24	4,5	2
28	5	3,2



Cestello vapore / *Steaming basket*

**cod. R5009822**

Ø cm	h cm
22	10,5



Coperchio / *Lid*

**cod. R50030..**

Ø cm	Master	cm Master	kg Master
16	12	26x23x33,5	1,8
18	12	26x23x36	2,11
20	12	31x20x46	2,41
22	12	31x20x46	2,94
24	12	31,5x33,5x45	3,72
26	12	31x34x45,5	4,24
28	12	31x34x45,5	5,22



# COMFORT R650

18/0

Con manico in bachelite e fondo termodiffusore.  
With bakelite handle and thermal diffusion bottom.

Made in Italy 

NICKEL  
FREE



INDUZIONE  
INDUCTION



GAS  
GAS



CERAMICO  
CERAMIC



ALOGENO  
HALOGEN



ELETTRICO  
ELECTRIC

Pentola / Pot

cod. R65003..

Ø cm	h cm	Lt
16	12	2,1
18*	13	2,8
20	14,5	3,8
22	14,7	5
24	17,1	6,5
28*	18	10,5

\* In esaurimento / Discontinued



Casseruola / Casserole

cod. R65005..

Ø cm	h cm	Lt
16	7,5	1,3
18	8	1,8
20	9,4	2,4
22	10,5	3,5
24	11,4	4,8
26	13	5,4
28	14	8



Tegame / Roasting pan

cod. R65023..

Ø cm	h cm	Lt
24	4,5	2
28	5	3,2



Casseruola 1 manico / Saucepan

cod. R65006..

Ø cm	h cm	Lt
12	5	0,5
16	7,5	1,3



Bollilatte / *Milkpot*  
**cod. R6506012**

Ø cm	h cm	Lt
12	9	0,9



Padella / *Frying pan*  
**cod. R65025..**

Ø cm	h cm	Lt
24	4,5	2
28	5	3,2



Cestello vapore / *Steaming basket*  
**cod. R6509822**

Ø cm	h cm
22	10,5



Coperchio / *Lid*  
**cod. R65031..**

Ø cm
16
18
20
22
24
26
28



# FIRST R800

18/10

Fondo 3 strati.  
3 layers bottom.

Articoli venduti in scatola litografata.  
Articles are packed in lithographed box.

In esaurimento / Discontinued



INDUZIONE  
INDUCTION



GAS  
GAS



CERAMICO  
CERAMIC



ALOGENO  
HALOGEN



ELETTRICO  
ELECTRIC

Pentola bassa con coperchio / *Low pot with lid*  
**cod. R800V3..**

Ø cm	Lt
20	3,1
24	6,3
28	11



Casseruola con coperchio / *Casserole with lid*  
**cod. R800V1..**

Ø cm	Lt
20	2,5
24	4,5



Casseruola 1 manico / *Saucepan*  
**cod. R8000616**

Ø cm	Lt
16	1,5



Bollilatte / *Milk pot*  
**cod. R8006014**

Ø cm	Lt
14	1,5



# FIRST R800

18/0

4 Sistemi di Sicurezza.  
4 Safety Systems.

INDUZIONE / INDUCTION



INDUZIONE  
INDUCTION



GAS  
GAS



CERAMICO  
CERAMIC



ALOGENO  
HALOGEN



ELETTRICO  
ELECTRIC

Pentola a pressione tradizionale  
*Traditional pressure cooker*

cod.	Lt	Ø cm
R8005103	3,5	20
R8005105	5	20
R8005107	7	20
R8005109	9	22



Set pentole a pressione Lt 5+7  
*Pressure cooker set Lt 5+7*

**cod. R8005D57**

Ø cm	Lt
20	5+7

Pentola Ø cm 20 5 lt,  
Pentola Ø cm 20 7 lt,  
Coperchio in acciaio  
inox 18/0 per pentola  
a pressione Ø cm 20,  
Coperchio in vetro  
Ø cm 20.

*18/0 stainless steel pot Ø  
20 cm 5L capacity, 18/0  
stainless steel pot Ø 20 cm  
7L capacity, 18/0 pressure  
cooker Ø 20 cm lid, Ø 20  
cm glass lid.*



**RICAMBI / SPARE PARTS**

cod. R800500 coperchio completo / lid for pressure cooker



# TENDER ALU EASY

Alluminio con rivestimento antiaderente GREBLON COMPOUND professionale a 3 strati, senza PFOA.

Aluminum with GREBLON COMPOUND professional non-stick coating (3 layers), PFOA free.

Manici in tubolare d'acciaio atermico e applicati con rivetti.

Riveted tubular stainless steel handles.



GAS  
GAS



CERAMICO  
CERAMIC



ALOGENO  
HALOGEN



ELETTRICO  
ELECTRIC

In esaurimento / Discontinued

Padella bassa con antiaderente / *Non-stick low frying pan*

**cod. 350925..**

Ø cm	h cm	Lt
20	4,0	1,0
24	4,5	1,6
28	5,2	2,6
32	6,0	4,0
36	6,7	5,7
40	7,5	7,9
45	8,4	11,2



Padella alta con antiaderente / *Non-stick deep frying pan*

**cod. 3509C5..**

Ø cm	h cm	Lt
20	4,7	1,2
24	5,4	2,0
28	6,3	3,3
32	7,2	5,0
36	8,1	7,1



Padella bassa / *Low frying pan*

**cod. 350025..**

Ø cm	h cm	Lt
20	4,0	1,0
24	4,5	1,6
28	5,2	2,6
32	6,0	4,0
36	6,7	5,7
40	7,5	7,9
45	8,4	11,2



Padella alta / *Deep frying pan*

**cod. 3500C5..**

Ø cm	h cm	Lt
20	4,7	1,2
24	5,4	2,0
28	6,3	3,3
32	7,2	5,0
36	8,1	7,1





# POP 3790

Alluminio stampato in 2,5 mm con rivestimento antiaderente XYLAN 2 strati.  
2,5 mm pressed aluminum with XYLAN 2 layers non-stick coating.

Fondo HOLE INDUCTION.  
Bottom: HOLE INDUCTION.

Manici in bakelite atermica.  
Handle with "stay-cool" bakelite material.

NICKEL  
FREE



INDUZIONE  
INDUCTION



GAS  
GAS



CERAMICO  
CERAMIC



ALOGENO  
HALOGEN



ELETTRICO  
ELECTRIC

Casseruola alta con coperchio / *Deep casserole with lid*  
**cod. 3790V1..**

Ø cm	h cm	Lt
20	7,7	2,4
24	10,5	4,8



Casseruola 1 manico / *Saucepan*  
**cod. 37900616**

Ø cm	h cm	Lt
16	6,7	1,3



Wok con coperchio / *Wok with lid*  
**cod. 37909528**

Ø cm	h cm	Lt
28	7,67	4,1



Crepiera / *Crepe frying pan*  
**cod. 37904525**

Ø cm	h cm	Lt
25	1,61	0,7



Bistecchiera / *Grill pan*  
**cod. 37905326**

Ø cm	h cm	Lt
26	3,98	2,3



Set 2 padelle  
Set 2 frying pans

cod.	Ø cm
<b>37902503</b>	20+24
<b>37902504</b>	24+28



Set 3 padelle  
Set 3 frying pans

cod.	Ø cm
<b>37902500</b>	20+24+28



Padella / Frying pan  
cod. 379025..

Ø cm	Lt
20	1,1
22	1,3
24	1,8
26	1,9
28	2,8
30	3,0



padella con manico e maniglia / frying pan  
with counter handle  
cod. 37902532

Ø cm	h cm	Lt
32	5,39	3,9



# POP EXTRA 3790

Alluminio stampato in 2 mm con rivestimento antiaderente 2 strati.  
2 mm pressed aluminum with 2 layers non-stick coating.

Manico in bakelite atermica.  
Handle with "stay-cool" bakelite material.

NICKEL  
FREE



GAS  
GAS



CERAMICO  
CERAMIC



ALOGENO  
HALOGEN



ELETTRICO  
ELECTRIC

Padella pancake e uova / Egg & pancake frying pan  
cod. 37902G25

Ø cm  
25



# COOK-IT

## 3190

Alluminio stampato con rivestimento antiaderente 5 strati.  
Pressed aluminum with 5 layers non-stick coating.

**Made in Italy** 

Manico in materiale termoisolante antiscottatura.  
Handle with "stay-cool" material.

NICKEL  
FREE



GAS  
GAS



CERAMICO  
CERAMIC



ALOGENO  
HALOGEN



ELETTRICO  
ELECTRIC

Padella / *Frying pan*  
**cod. 319025..**

Ø cm

20

24

28



Padellino uovo / *Egg frying pan*  
**cod. 31902514**

Ø cm

14



Crepiera / *Crepe frying pan*  
**cod. 31904525**

Ø cm

25



Gira frittata / *Omelette pan*  
**cod. 31902D26**

Ø cm

26



# X-BLACK 4180

Alluminio forgiato con rivestimento antiaderente senza PFOA.  
Forged aluminum with PFOA-free non-stick coating.

Bordo rinforzato 3,5 mm.  
3.5 mm reinforced rim.

Manici in bakelite atermica.  
Handle with "stay-cool" bakelite material.

NICKEL  
FREE



INDUZIONE  
INDUCTION



GAS  
GAS



CERAMICO  
CERAMIC



ALOGENO  
HALOGEN



ELETTRICO  
ELECTRIC

Casseruola fonda con coperchio / *Deep casserole with lid*  
**cod. 4180V1..**

Ø cm	Lt
20	2,3
24	4,2
28	6,6



Casseruola fonda / *Deep casserole*  
**cod. 418005..**

Ø cm	Lt
20	2,3
24	4,2
28	6,6



Casseruola 1 manico / *Saucepan*  
**cod. 41800616**

Ø cm	Lt
16	1,2



Wok con coperchio / *Wok with lid*  
**cod. 41809528**

Ø cm	Lt
28	3,5



Wok / *Wok*  
**cod. 41809S28**

Ø cm	Lt
28	3,5



Crepiera / Crepe frying pan  
**cod. 41804525**

Ø cm	Lt
25	0,5



Bistecchiera / Grill pan  
**cod. 41805328**

Ø cm	Lt
26	2,2



Set 2 padelle / Set 2 frying pans  
**cod. 41802504**

Ø cm
24+28



Padella / Frying pan  
**cod. 418025..**

Ø cm	Lt
20	1,0
24	1,6
26	2,0
28	2,4
30	3,3



Coperchio / Lid  
**cod. 40403A..**

Ø cm
20
22
24
26
28



# SMART 4240

Alluminio stampato con rivestimento antiaderente senza PFOA.  
Stamped aluminum with PFOA-free non-stick coating.

Manico in bakelite atermica.  
Handle with "stay-cool" bakelite material.

NICKEL  
FREE



INDUZIONE  
INDUCTION



GAS  
GAS



CERAMICO  
CERAMIC



ALOGENO  
HALOGEN



ELETTRICO  
ELECTRIC

Set 2 padelle / *frying pans set*  
cod. 42402501

Ø cm

24+28



# PORTOFINO

## 305\_

Alluminio con rivestimento antiaderente 5 strati, senza PFOA.  
Aluminum with 5-layer non-stick coating PFOA free.

**Made in Italy** 

Manico in materiale antiscottatura.  
Handle with thermosetting material.

NICKEL  
FREE



GAS  
GAS



CERAMICO  
CERAMIC





ALOGENO  
HALOGEN



ELETRICO  
ELECTRIC

### Padella / Frying pan

cod.	Ø cm	colour
305B2520	20	
305B2524	24	ROSA
305B2528	28	TRAMONTO
305C2520	20	
305C2524	24	BLU
305C2528	28	MARE
305A2520	20	
305A2524	24	VERDE
305A2528	28	BASILICO



**GASTRONORM**

# GN-P

## RBA\_

Gastronorm in acciaio inox 18/10.  
18/10 stainless steel gastronorm.

### Bacinella 1/1 Basin 1/1

cod.	OUT mm	h mm	Lt	Master	cm Master	kg Master
<b>RBA11020</b>	530x325	20	tray	5	35x55x10	5,25
<b>RBA11040</b>		40	5,4		35x55x10	5,15
<b>RBA11065</b>		65	8,7		35x55x10	7,58
<b>RBA11100</b>		100	13,0		35x55x20	7,99
<b>RBA11150</b>		150	20,0		35x55x30	10,40
<b>RBA11200</b>		200	26,0		35x55x34	11,42

### Bacinella 1/2 Basin 1/2

cod.	OUT mm	h mm	Lt	Master	cm Master	kg Master
<b>RBA12020</b>	325x265	20	tray	10	34x38x10	4,60
<b>RBA12040</b>		40	2,4	10	34x38x10	5,13
<b>RBA12065</b>		65	3,8	10	35x55x10	5,97
<b>RBA12100</b>		100	5,9	10	35x55x20	9,37
<b>RBA12150</b>		150	8,7	5	34x38x20	6,07
<b>RBA12200</b>		200	11,0	5	35x55x25	5,88

### Bacinella 1/3 Basin 1/3

cod.	OUT mm	h mm	Lt	Master	cm Master	kg Master
<b>RBA13065</b>	325x176	65	2,5	10	35x55x10	5,76
<b>RBA13100</b>		100	3,8		34x38x20	6,49
<b>RBA13150</b>		150	5,5		34x38x20	6,49
<b>RBA13200</b>		200	7,0		35x55x20	9,15

### Bacinella 1/4 Basin 1/4

cod.	OUT mm	h mm	Lt	Master	cm Master	kg Master
<b>RBA14020</b>	265x162	20	tray	10	17x27x10	2,62
<b>RBA14040</b>		40	1,2	10	17x27x10	3,72
<b>RBA14065</b>		65	1,7	10	17x27x20	3,78
<b>RBA14100</b>		100	2,7	20	35x55x20	10,20
<b>RBA14150</b>		150	3,8	10	35x55x20	5,17
<b>RBA14200</b>		200	4,8	10	35x55x30	9,34

Bacinella 1/6  
Basin 1/6

cod.	OUT mm	h mm	Lt	Master	cm Master	kg Master
<b>RBA16065</b>	176x162	65	1,0	20	17x27x20	5,00
<b>RBA16100</b>		100	1,6		35x55x20	6,61
<b>RBA16150</b>		150	2,2		34x38x20	8,34
<b>RBA16200</b>		200	2,8		35x55x20	10,66

Bacinella 1/9  
Basin 1/9

cod.	OUT mm	h mm	Lt	Master	cm Master	kg Master
<b>RBA19065</b>	176x108	65	0,6	30	34x38x20	7,47
<b>RBA19100</b>		100	0,9		34x38x20	8,51

Bacinella 2/1  
Basin 2/1

cod.	OUT mm	h mm	Lt	Master	cm Master	kg Master
<b>RBA21020</b>	650x530	20	tray	5	56x67x10	11,88
<b>RBA21040</b>		40	12,0		56x67x10	11,75
<b>RBA21065</b>		65	19,0		56x67x10	13,76
<b>RBA21100</b>		100	29,0		56x67x20	15,25
<b>RBA21150</b>		150	43,0		56x67x27	18,34
<b>RBA21200</b>		200	57,0		56x67x27	21,13

Bacinella 2/3  
Basin 2/3

cod.	OUT mm	h mm	Lt	Master	cm Master	kg Master
<b>RBA23020</b>	354x325	20	tray	10	34x38x10	5,86
<b>RBA23040</b>		40	3,4		34x38x10	8,40
<b>RBA23065</b>		65	5,5		34x38x20	10,37
<b>RBA23100</b>		100	8,4		34x38x30	12,89
<b>RBA23150</b>		150	12,0		34x38x35	14,00
<b>RBA23200</b>		200	16,0		34x38x35	14,04

Coperchio bacinella  
Basin lid

cod.	Mod.	OUT mm	h mm	Lt	Master	cm Master	kg Master
<b>RCO11000</b>	1/1	530x325	-	-	10	35x55x20	10,86
<b>RCO12000</b>	1/2	325x265	-	-	10	34x28x20	5,38
<b>RCO13000</b>	1/3	325x176	-	-	10	34x28x10	3,52
<b>RCO14000</b>	1/4	265x162	-	-	10	17x27x20	2,60
<b>RCO16000</b>	1/6	176x162	-	-	20	34x28x10	3,64
<b>RCO19000</b>	1/9	176x108	-	-	20	17x27x20	2,51
<b>RCO23000</b>	2/3	354x325	-	-	10	34x38x20	7,98

# MULTIPLI: LE COMBINAZIONI

## Multiples: the combinations

2/1



1/1



2/3

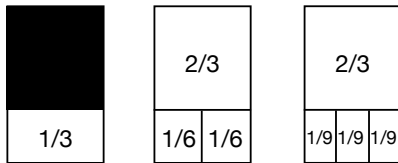

1/2

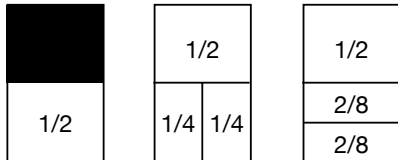

2/4

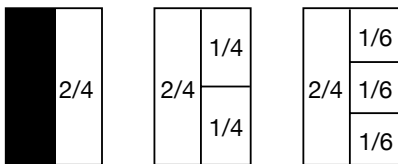

1/3

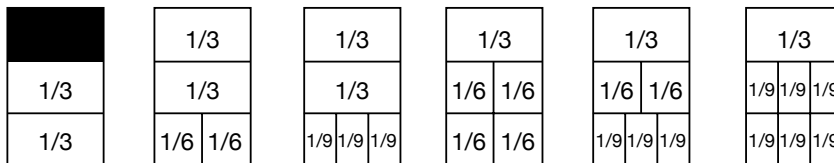

1/4

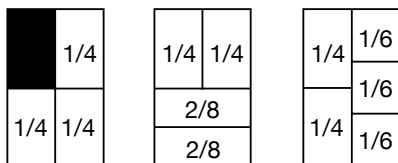

2/8

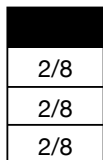

1/6

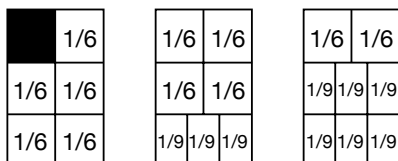

1/9



**UTENSILI DA CUCINA**  
KITCHEN TOOLS

# GADGET FAST 7820

Acciaio inox con manico in polipropilene ergonomico.  
Stainless steel with ergonomic handle in polipropilene.

Design bicolore e packaging dedicato per ogni articolo.  
Two-tones design and dedicated packaging for each item.

Spremi aglio / *Garlic press*  
**cod. 78200001**



Apribottiglia / *Bottle opener*  
**cod. 78200002**



Scavino melone / *Melon baller*  
**cod. 78200003**



Pelapatate / *Peeler*  
**cod. 78200004**



Pelapatate multiuso  
con lama liscia / *Peeler plain*  
**cod. 78200005**



Pelapatate multiuso con lama  
seghettata / *Peeler serrated*  
**78200006**



Dosatore gelato / *Ice-cream scoop*  
**cod. 78200007**



Coltello burro / *Butter knife*  
**cod. 78200008**



Riga limoni / *Lemon zester*  
**cod. 78200009**



Rotella taglia pizza / *Pizza cutter*  
Ø cm 10  
**cod. 78200010**



Rotella taglia pizza / *Pizza cutter*  
Ø cm 6,5  
**cod. 78200011**



Rotella seghettata / *Pastry wheel serrated*  
Ø cm 5,5  
**cod. 78200012**



Rotella doppia / *Pastry wheel double*  
**cod. 78200013**



Scava zucchine / *Zucchini corer*  
**cod. 78200014**



Affilacoltelli / *Knife sharpener*  
**cod. 78200015**



Leva torsolo / *Apple corer*  
**cod. 78200016**



Tagliaverdure / *Vegetable cutter*  
**cod. 78200017**

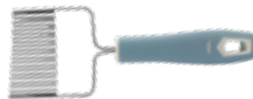

Grattugia lama fina / *Fine grater*  
**cod. 78200018**



Grattugia lama grossa / *Coarse grater*  
**cod. 78200019**



Pala taglia formaggi / *Cheese slicer*  
**cod. 78200020**



Pala torta / *Cake server*  
**cod. 78200021**



Pala pizza seghettata / *Pizza-pie server*  
**cod. 78200022**





# GADGET FPR

## 782F

Acciaio inox con manico in polipropilene ergonomico.  
Design bicolore e packaging dedicato per ogni articolo.

Stainless steel with ergonomic handle in polipropilene.  
Two-tones design and dedicated packaging for each item.

Apribottiglia / *Bottle opener*  
cod. 782F0002



Scavino melone / *Melon baller*  
cod. 782F0003



Pelapatate / *Peeler*  
cod. 782F0004



Pelapatate ad arco / *Y-peeler*  
782F0025



Dosatore gelato / *Ice-cream scoop*  
cod. 782F0007



Spatola / *Turner*  
cod. 782F0022



Pennello in silicone / *Silicone brush*  
cod. 782F0023



Rotella taglia pizza / *Pizza cutter*  
Ø cm 6,6  
cod. 782F0011



Leva torsolo / *Apple corer*  
cod. 782F0016



Grattugia / *Grater*  
cod. 782F0024



Apriscatole / *Can opener*  
cod. 782F0026



Mestolo salsa / *Sauce ladle*  
cod. 782F0029



Pala fritto / *Spatula*  
cod. 782F0030



Cucchiaione / *Serving spoon*  
cod. 782F0031



Servispaghetti / *Spaghetti server*  
cod. 782F0032



Forchettone / *Carving fork*  
cod. 782F0033



Mestolo / *Ladle*  
cod. 782F0028



Frusta / *Whisk*  
cod. 782F0034



Schiumarola / *Skimmer*  
cod. 782F0027



Colino / *Strainer*  
cod. 782F0035



Schiaccianoci / *Nutcracker*  
cod. 782F0036



Cavatappi due leve / *Corkscrew winged*  
cod. 587F4100



Cavatappi professionale / *Professional corkscrew*  
cod. 587F4300



Batticarne / *Meat mallet*  
cod. 782F0037



Apribarattoli / *Jar opener*  
cod. 782F0038



Frullino / *Manual whisk*  
cod. 782F0039



Frusta in silicone / *Silicone whisk*  
**cod. 782F0040**



Frangi fiamma / *Heat diffuser*  
**cod. 782F0041**



Para spruzzi / *Splash guard*  
**cod. 782F0043**



# SMART

## 5217

Nylon PA66 - Max 210°C

Consigliati per padelle antiaderenti.  
Recommended for non-stick frying pans.

Cucchiaio / *Serving spoon*  
cod. 52170000



Cucchiaio forato / *Perforated spoon*  
cod. 52170100



Mestolo / *Ladle*  
cod. 52172000



Schiumarola / *Skimmer*  
cod. 52174000



Servispaghetti / *Spaghetti server*  
cod. 52177000



Spatola / *Spatula*  
cod. 52176000



Spatola forata / *Perforated spatula*  
cod. 52173000



Frusta / *Whisk*  
cod. 52171800



Pinza / *Chef tong*  
cod. 52179100





PINTI INOX S.p.A.  
Via Antonini, 87  
25068 Sarezzo (BS) Italia  
Tel. +39 030 89351  
Fax +39 030 8935250  
+39 030 8901163  
[www.pintinox.com](http://www.pintinox.com)  
[pintinox@pinti.it](mailto:pintinox@pinti.it)

---

PINTI INOX GMBH  
DEUTSCHLAND  
Römerstraße 91  
73066 Uhingen  
Tel +49 07161 93343-0  
Fax +49 07161 352789  
[www.pinti.de](http://www.pinti.de)  
[info@pinti.de](mailto:info@pinti.de)